



- Wire Grips & Socks
- Cable pullers & winches
- Hoists & Dynamometers
- Joints & Swivels
- Stringing Rollers
- Pulling Rope

OVERHEAD STRINGING EQUIPMENT



NOTES

A series of horizontal dotted lines spanning the width of the page, intended for handwritten notes.

OVERHEAD STRINGING EQUIPMENT - TABLE OF CONTENTS

Grips, Come-a-long - Wire / Conductor	A4	Hand Line and Rope Blocks - Multipurpose	A20
Grips - Nagaki (NGK).....	A4	Multipurpose snatch-block - OX Block™.....	A20
Grip Selection Chart - Nagaki (NGK).....	A4	Hand Line Blocks	A21
Grips - Klein.....	A5	Single Non-Conductive Hand-line Block.....	A21
Grips and Liners - Riganti.....	A5	Hand-line Hook.....	A21
Hoists	A6	Service Line Tensioners.....	A21
Web Strap Ratchet Hoists - Nagaki NGK.....	A6	Pole Platform - Steel, Concrete & Wooden	A21
Wire Rope Hoists - Nagaki NGK.....	A6	Pole Handling	A22
Web Strap Hoists - Lug-All	A7	Pole Stands - Flat Stack - TEN.....	A22
Cable Hoists - Lug-All	A7	Pole Stands - Lightweight.....	A22
Chain Hoists 0.75 and 1.5T - Nagaki (NGK)	A8	Cant Hooks - Fibreglass Section	A22
Chain Hoists 3, 4 and 6T - Nagaki (NGK).....	A8	Conductor Handling Equipment	A23
Cable Hoist 500 to 3200kg - Yaletrac ST.....	A8	Temporary Crossarm - Termination & Intermediate	A23
Chain Hoists - Vital.....	A9	Triple Line Lifter - "T" Style - LineWise	A23
Chain Hoists - KITO.....	A9	Triple Line Lifter - Articulated Style - LineWise	A23
Dynamometers	A9	Hydraulic Pole Pullers	A24
Tension Meter - Quick-Check "T" - Dillon.....	A9	Pole Puller - Hydraulic - 56T	A24
Mechanical Dynamometers - Nagaki (NGK)	A10	Pole Puller, Hydraulic 22T - Reliable	A24
Mechanical Dynamometers - Dillon	A10	Transformer Oil Containment	A25
Digital Bluetooth Dynamometers - BlueMax.....	A10	BOB® - ABG.....	A25
Digital Dynamometers - EDJunior - Dillon	A11	FLEXTRAY® - ABG	A25
Digital Dynamometers - EDXtreme Red - Dillon	A11	Pole Setting	A26
Digital Dynamometers - EDXtreme Blue - Dillon	A11	Dirt Tarps - Slingco	A26
Socks and Grips, Cable Overhead	A12	POLESETTER ROCKBAG - ABG	A26
Non-Metallic Aramid Socks - Slingco.....	A12	Pulling Rope	A27
Non-Conductive Nylon Socks - NCG	A12	ROBUS Dyneema Rope - Hampidjan	A27
Cable Pulling Grips - Slingco	A13	Polypropylene Rope - 3 Strand - Hampidjan	A27
High Strength Cable Grips - Slingco	A13	Double Braided Hauling Rope - Hampidjan.....	A27
Heavy Duty Large Eye Cable Socks - Tesmec	A14	Dielectric Ropes	A28
Double Head Socks - Tesmec.....	A14	D.E.W Line™ - Barry.....	A28
Joints and Swivels	A15	Tag Line	A28
Standard Swivels - Tesmec	A15	Live Line Rope	A28
Rope to Swivel Connector - Slingco	A15	Live Line Rope Link.....	A28
Rope to Rope Connector - Slingco	A15	Rescue Rope.....	A29
Fixed Joints - Tesmec	A16	Safety Nets	A29
Anchor Rod Pulling Eye - SPP	A16	Insulating - Live Line Rope	A29
Lifting Gin - Hastings	A16	Insulating Rope - 3 Strand	A29
Cross-Arm Slings - Miller	A16	Petrol Portable Capstan Winch	A30
Stringing Rollers and Attachment Brackets	A17	Portable Petrol Capstan Winch - Docma	A30
Angle Insulator Roller - SPP	A17	Winch Mounting Accessories - Docma.....	A30
ABC Rollers - SPP	A17	Winch Mounting Accessories - Docma (cont.)	A31
Cross-arm Roller - SPP	A17	Hydraulic Puller	A31
Universal Stringing Roller - SPP.....	A18	Hydraulic Puller - 30kN Digital HMI - Tesmec	A31
Universal Roller Bracket -SPP	A18	Battery Capstan Winches	A32
Universal Stringing Roller - SPP.....	A19	Battery Capstan Winches - 1360kg - iTOOLco	A32
Cross Arm bracket - SPP	A19	Battery Capstan Winch - 1360kg - iTOOLco.....	A32
Ball Clevis Socket Fittings.....	A19	Battery Capstan Winches - 2727kg - iTOOLco	A33
Tie Top Post Insulator Bracket - SPP.....	A19	Electric Capstan Winches	A33
Pin Insulator Roller - SPP	A19	Electric Capstan Winch - 5450kg - iTOOLco	A33

NAGAKI



SD-L-GRIPL/W



AL-2TON-GRIP-L*
Locking Option

Grips, Come-a-long - Wire / Conductor

Used to grip Conductors (AL, Cu, ACSR), Wire Rope, Steel, ABC, Amokabel and CCT during tensioning.

Grips - Nagaki (NGK)

- Manufactured from high tensile alloy steel, hot forged, heat-treated, precision machined and zinc-plated
- Safety latch on all models
- "L" suffix denotes Locking Grip
- Add "TB" suffix for Bent Eye option



AL-10TON-GRIP



ABC-GRIP

Grip Selection Chart - Nagaki (NGK)

Part No.	Min - Max Dia. (mm)	WLL (kN)	Jaw Length (mm)	Jaw Type	Wt (kg)	Safety Latch	Suitable for Wire/Cable	Eye Width (mm)	Notes
MINI-GRIP	1 - 10	5	NA	Serrated	0.3	No	Steel Rod, Barbed & Catenary Wire	16	Curved Jaw
SD-L-GRIPL/W	2.6 - 15	10	34	Serrated	0.6	Yes	Steel Rod/Wire, Bare Cu & Catenary Wire	26	Large Eye
MESSENGER-L-GRIP-L	4 - 12	10	50	Serrated	0.7	Yes	Bare Cu & Catenary Wire	26	Double Lock Nut
1TON-L-GRIP	4 - 22	10	60	Serrated	1.4	Yes	Bare Cu, Covered Conductor & Catenary Wire	32	Large Eye
2TON-L-GRIP	4 - 22	20	60	Serrated	1.4	Yes		32	Large Eye
MIDDLE-L-GRIP	5 - 25	20	110	Serrated	1.8	Yes		32	Large Eye
CCT-GRIP	5 - 25	20	110	Serrated	1.8	Yes	CCT Up to 180mm ² (11kV) Up to 80mm ² (22kV)	32	Large Eye
2TON-W-GRIP	5 - 16	20	100	Serrated	1.8	Yes	Bare Cu, Wire Rope, Catenary Wire & Rail Contact Wire	32	Large Eye
3TON-GRIP	8 - 22	30	120	Serrated	3.1	Yes		34	-
4TON-GRIP	13 - 28	40	150	Serrated	5.0	Yes		50	-
6TON-GRIP	13 - 28	60	150	Serrated	5.2	Yes		25	-
10TON-GRIP	18 - 32	100	180	Serrated	10.0	Yes	Wire rope, Catenary Wire	60	-
AL-L-GRIP	5 - 22	10	60	Smooth	1.1	Yes	ACSR & Bare AL	32	Fine smooth jaw, less chance of conductor damage
AL-2TON-GRIP-L	5 - 20	20	100	Smooth	1.7	Yes		32	
AL-MIDDLE-GRIP*	5 - 25	20	110	Smooth	1.8	Yes		32	
AL-MIDDLE-GRIP-L	5 - 25	20	110	Smooth	2.9	Yes		32	
AL-LARGE-GRIP*	16 - 32	20	110	Smooth	2.0	Yes		32	
AL-3TON-GRIP	8 - 22	30	120	Smooth	3.0	Yes		34	
AL-4TON-GRIP	20 - 35	40	140	Smooth	3.7	Yes		34	
HOT-M-GRIP	5 - 25	20	110	Smooth	2.0	Yes		ACSR & Bare AL	
HOT-L-GRIP	16 - 32	20	110	Smooth	2.0	Yes	32		
AL-10TON-GRIP	32-46	100	300	Smooth	14	Yes	63		Smooth jaw
TROLLEY-GRIP1L-S	5 - 16	20	100	Serrated	1.5	Yes	Rail Contact Wire, Bare Cu, Catenary Wire, Guy & Wire Rope	32	Large Eye
TROLLEY-GRIP-2-L	8 - 20	20	150	Serrated	2.8	Yes		25	Large Eye
TROLLEY-GRIP-4-L	13 - 28	40	150	Serrated	5.2	Yes		32	Large Eye
ABC-GRIP-S	2x16 & 4x35mm ²	6.0	130	Serrated	1.8	Yes	ABC - 2 x 16mm ² to 4 x 35mm ²	32	Large Eye
ABC-GRIP-M	4x35 & 4x95mm ²	8.5	190	Serrated	3.3	Yes	ABC - 4 x 35mm ² to 4 x 95mm ²	35	Large Eye
ABC-GRIP-L	4x95 & 4x150mm ²	20	190	Serrated	3.3	Yes	ABC - 4 x 95mm ² to 4 x 150mm ²	35	Large Eye

KLEIN TOOLS



- Klein wire grips are suitable for pulling various conductors and cables
- All Klein Grips are manufactured from drop-forged steel that is machined and heat treated for excellent durability

Grips - Klein

Part No. Various

Part No.	Min - Max Ø (mm)	WLL (kg)	Jaw Type	Jaw Length (mm)	Suitable for	Wt (kg)
S1613-40H	3 - 9.4	2041		106	Aircraft Cable, EHS, Messenger and Guy Strand. With hot latch and spring	1.4
1604-20L	3.2 - 12.7	2268		-	Messenger and Guy Strand (Knurled Jaw may damage cable)	1.0
1685-20	4 - 22	2041		64	Bare AL, Cu, ACSR	1.3
1625-20	7.1 - 19	3636		-	Wire Rope - where damage is not an issue	1.8

RIGANTI

Made in Switzerland by Powercom



Refer Transmission Section for further information on Grips and Liners

IR-3112 with 15.8mm AL to AL Liners (IR311215.8AL) is suitable for CCSX62 Amokabel

Grips and Liners - Riganti

Part No. Various

Riganti's self-gripping comealongs are available for aluminium, ACSR, steel earth-wire, anti-twisting rope, copper and OPGW conductors.

- High tensile alloy steel, hot forged, heat-treated, and zinc-plated
- Complete range of interchangeable liners
- Liners are available in aluminium and bronze for copper conductors, steel anti-twisting rope and steel earth-wire
- OPGW lower liner is made of Adiprene, the upper liner is made of aluminium.
- Special clamps with exact diameters available on request with or without liners

Part No.	Working Load Limit (kN)	Min Breaking Load (kN)	Liners	Al, ACSR & Cu (mm)		wSteel, Earth-wire (mm)		Anti-twist Steel Rope (mm)		Wt (kg)
				Min	Max	Min	Max	Min	Max	
IR-3109	19.6	49	✗	2.5	15	2.5	15	2.5	15	1.5
IR-3111 *	21.2	64	✓	7	16	7	13	7	13	2.5
IR-3108 *	39.5	110	✓	Lifting suspension conductors 7 - 38mm						5.5
IR-3106	50	125	✗	7.5	18	7.5	18	7.5	13	7
IR-3107 *	49	180	✓	6	23	6	16	6	16	7
IR-3112 *	49	180	✓	OPGW 6 - 23mm						7
IR-3105-S *	88	275	✓	8	35.2	8	22	8	24	13.5
IR-3104-S *	117	310	✓	10	45	10	34	8	28	17

* Exact size required for manufacture of liners

IMPORTANT

The "SAFETY" of your personnel and the longevity of your equipment depends on the Correct use, Inspection, Cleaning and Maintenance.



For more information on the care and maintenance of your Grips, CLICK or SCAN the QR-Code

Correct use

- Operators should be trained in the relevant job at hand
- Read and understand the Instruction/ Operators Manual
- Ensure you have selected the correct grip for the conductor type, size and tension, as well as the ancillary equipment. (e.g. max tension of hoist).

Manufacturers Grips Supported by TEN



Contact TEN for cleaning equipment



N-1500P-EX

Favoured by line crews for its compact size and weight

Hoists

Web Strap Ratchet Hoists - Nagaki NGK

Part No. Various

Nagaki web strap hoists feature insulated super-strength 32mm wide web straps, insulated Fibreglass handles and a special handle neck that will bend if the unit is overloaded to prevent damage to the puller and injury to the operator.

- Convertible series with 3 hooks
- Lightweight
- Insulated handles rotate 360°
- Controlled smoother release of load
- Made in Japan from Japanese components



NEW Patented Handle

Constructed solid one piece section, and provides exceptional durability and performance

- Interchangeable with previous Handles
- Available for Web-strap N-1000, N-1500 models



N-1500-P Shown with NEW patented Handle



P-1500-EX

Part No.	WLL (T)	Min Pull (mm)	Max Pull (mm)	Handle Length (mm)	Wt (kg)	Spare Strap Part No.
N-1000P	1.0	440	1940	400	3.3	PNGK-N-1000P-20
N-1500P	1.5	470	1970	460	4.6	PNGK-N-1500P-20
N-1500P-EX	0.75 Single 1.5 Double	500	2000 Double 3500 Single	460	4.5	PNGK-N-1500PEX22
N-1500P-EX-L	Pulling: 0.75 Single 1.5 Double *Lifting: 200kg Single 400kg Double	500	2000 Double 3500 Single	460	5.0	PNGK-N-1500PEX22

Wire Rope Hoists - Nagaki NGK

Part No. Various

- Steel handle rotates 360°
- Made in Japan from Japanese components
- Convertible and Standard Configuration available

Part No.	WLL (T)	Min Pull (mm)	Max Pull (mm)	Handle Length (mm)	Wt (kg)
P-1500-C (Convertible)	0.75 Single 1.5 Double	460	1870 Double 3280 Single	430	4.3
P-1500-EX	0.75 Single 1.5 Double	500	3500 Double 6500 Single	430	5.0

LUG-ALL®
THE ORIGINAL & THE BEST



Web Strap Hoists - Lug-All

Part No. Various

- Positive Load Holding in all Environments – Interlocking pawl mechanism, no load brakes to slip or foul
- Ease of Operation – Self lubricating bearings throughout housing and on pulley assures smooth operation
- Stress Link – Signals operator by breaking replaceable link before overloading hoist
- Double Flanged Drum – Prevents web strap from coming in contact with ratchet teeth
- All Lug-All's meet the current (2014) ANSI/ASME B30.21-2014 standard for "manually operated lever hoists"

4.7m
Single pull
distance

See chart below for replaceable Stress Link



35-A-1300-ANZ
Medium Frame
Lightweight



Lug-All Standard & Lightweight Models

Part No.	Frame Size	Feature	Single Line		Double Line		Handle Length (mm)	Net Wt (kg)	Stress Link
			Capacity (kg)	Max (m)	Capacity (kg)	Max (m)			
2-A-1300-ANZ	Small	Standard	450	2.9	900	1.3	420	4.6	PLA-614
25-A-1300-ANZ	Small	Lightweight	680	2.1	1360	1.1	330	4.5	PLA-636
3-A-1300-ANZ	Medium	Standard	680	3.4	1360	1.7	510	6.3	PLA-572
35-A-1300-ANZ	Medium	Lightweight	680	4.7	1360	2.2	760	5.8	PLA-572
40-A-ANZ	Medium	Lightweight	900	2.8	1814	1.2	910	6.0	PLA-572

CLICK or SCAN the QR-Code to check out Lug-All's Company Profile



Cable Hoists - Lug-All

LUG-ALL® Cable Hoists have been the most popular product for the last 6 decades as the leading tool for industrial uses.

Ideal for hundreds of tasks, including lifting, lowering, pulling, tensioning, stretching and bending, Construction & Renovation, Road & Bridge Construction & Repair, Structural Steel Erection, Welding Alignment, Pump & Motor Installation & Overhaul, Rigging, HVAC, Conveyor Repairs, Fence Tensioning, Tree Service, and Landscaping.

Super flexible, 133-strand aircraft cable and fast-connecting, 360° swiveling hooks with safety latches for quick, positive, loading and unloading.

- Lug-All wire rope hoists for lifting or pulling applications
- Reversible handle designed to bend on overload

- Use the entire cable length! The exclusive LUG-ALL swagged, ball-shank anchor locks the cables end into the drum
- Self lubricating bearings
- Quick release will not function when the cable is under load
- Non-slip interlocking pawl system
- Open Design – Easily inspected
- Aluminium alloy frame and drop forged steel hooks



2250-20-ANZ
Small Frame



3000-30-ANZ
Medium Frame



4000-20-ANZ
Medium Frame



6000-15-ANZ
Large Frame

Part No.	Frame Size	Single Line		Double line		Net Wt (kg)
		Capacity (kg)	Lift /Pull Distance (m)	Capacity (kg)	Lift /Pull Distance (m)	
Standard Model						
2250-20-ANZ	Small	500	6.0	1000	3.0	4.2
3000-30-ANZ	Medium	680	9.0	1360	4.5	6.3
4000-20-ANZ	Medium	900	6.0	1800	3.0	7.0
6000-15-ANZ	Large	1360	4.5	2720	2.2	15.4



RICKY-2

Chain Hoists 0.75 and 1.5T - Nagaki (NGK)

Part No. RICKY-2 & RICKY-3

- Lightweight aluminium housing with 5mm OD alloy chain link & forged hooks
- 1.5m pull
- 360° rotating handle of 230mm length
- Safety hook attachment
- All models manufactured under ISO9001 and ISO14001 standards

Suitable for Pulling/Tensioning

Part No.	Style	WLL (T)	Chain length (m)	Min Pull (mm)	Max Pull (mm)	Handle Length (mm)	Wt (kg)
RICKY-2	Safety Hook	0.75	1.5	300	1800	230	4.0
RICKY-3	Safety Hook	1.5		350	1850	230	5.0

Chain Hoists 3, 4 and 6T - Nagaki (NGK)

Part No. Various

- Lightweight aluminium housing with 5mm OD alloy chain link & forged hooks
- 360° rotating handle of 430mm length
- Safety hook attachment
- Special length chains available on request

Suitable for Pulling/Tensioning



MODEL3000

Part No.	Style	WLL (T)	Chain length (m)	Min Pull (mm)	Max Pull (mm)	Handle Length (mm)	Wt (kg)
MODEL2000C-1.5	Safety Hook	2	1.5	480	2000	430	6.6
MODEL3000-1.5	Safety Hook	3		480	2000	430	9.0
MODEL4000H-1.5	Safety Hook	4		580	2180	430	12
MODEL6000-1.5	Clevis	6		650	2250	430	19

Other chain lengths available - Contact TEN for further information

Model 4000 lightweight & ideal for Transmission tensioning

Cable Hoist 500 to 3200kg - Yaletrac ST

Part No. Various

The portable Yaletrac ST cable puller is a versatile tool for pulling, lifting, lowering, tensioning and securing loads over long distances

- Rope diameters from 6 to 16mm
- Various wire rope lengths available
- Contact TEN for further information



500kg Unit shown

USA MANUFACTURED QUALITY

VITAL®

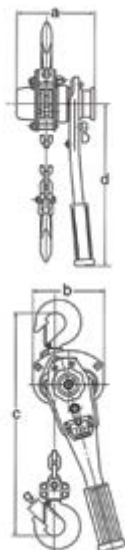

Chain Hoists - Vital

- Manufactured in Japan using high quality steel
- All Vital models are manufactured to comply with AS1418.2
- Unique design of bottom hook prevents slipping and ensures safe operation
- Easy two-step operation to prevent accidental free-wheeling
- Hardened alloy steel load chain with embossed identification, marked to relevant standards
- Standard lift height 1.5, 3.0 & 6.0m
- Load Chain Exceeds Australian Standards with 5:1 Safety Factor

Part No.	Rated Capacity (T)	Pull to Lift Load (kg)	Dimensions (mm)					Chain Falls	Wt (kg)
			A	B	C	D	G		
VLB107L	0.8	15	148	128	295	260	27	1	6.9
VLB115L	1.6	18	163	148	355	370	34	1	9.7
VLB130L	3.2	38	191	181	405	370	43	1	16.3
VLB160L	6.3	39	191	244	550	370	47	2	26.7

KITO

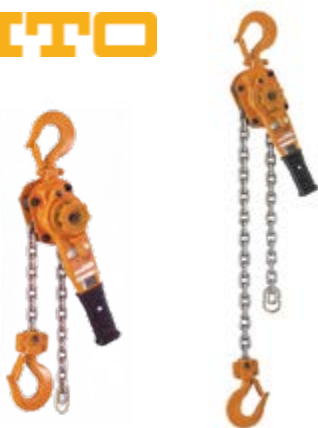

Chain Hoists - KITO

- Unique patented 'Free Wheeling Hub' mechanism.
- Smaller, lighter, high grade, alloy steel frame construction.
- All KITO models are manufactured to comply with AS1418.2
- Double brake pads with four braking surfaces.
- Double Pawl & Double Spring Assemblies
- KITO manufactured Nickel plated Grade 100 load chain
- Needle and Ball roller bearings allow maximum mechanical efficiency with minimum effort.
- Also available with overload limiter which prevents hoist overload and protects the operator

Suitable for Pulling & Lifting Applications

Part No.	WLL (T)	Chain length (m)	Max Pull (mm)	Handle (mm)	Wt (kg)
44202	0.8	1.5	1800	245	5.7
44204	1.6		1850	265	8.0
44206	3.2		2000	415	15.0
44207	6.3			415	26
45890	0.8	3.0	2180	245	6.8
45891	1.6		2250	264	9.7
45892	3.2		2250	415	18.5
45893	6.3			415	26

**9T Capacities available in 1.5m & 3.0m Chain Lengths
Contact TEN for further information**

DILLON QUICK CHECK



Quick Check "T" shown testing tower guy with phone APP

Dynamometers

Tension Meter - Quick-Check "T" - Dillon

The Dillon Quick Check-T Tension Meter quickly measures tension in cable tower guy wires, overhead lines and road barrier cables. It reduces time on the job site by not having to change sheaves.

- Custom mobile app
- Automatic report generation
- Calibration check rod
- Supplied with HD Case



Part No.	AWT05-100370	QC-T
No. of Calibrations	16 Tower guy + Test Rod	1 x Test Rod
Calibrations (") Up to 20	(1x7) 3/16, 1/4, 5/16, 3/8, 7/16, 1/2, 9/16, 5/8 (1x19) 1/2, 9/16, 5/8, 11/16, 3/4, 13/16, 7/8, 1	1 only, for test rod. Specify wire sizes
Capacities (kN/kg)	45 /4500 in Kilogram force & Newtons Units	
Wire sizes mm (")	4.75 to 25.4 (3/16 to 1)	
Weight (kg)	5	

OVERHEAD STRINGING EQUIPMENT

CONTENTS



NAGAKI



AS-30 Model



Leather Case (Included)

Mechanical Dynamometers - Nagaki (NGK)

NGK Dynamometers are lightweight, compact and plated to resist corrosion. All models feature a large face dial for easy reading of measurements.

- Made in Japan from Japanese components
- Precise measurement of tension and loads
- Kilogram/force (kN) dial display
- Accuracy $\pm 3\%$
- Supplied with In-Service Date sticker

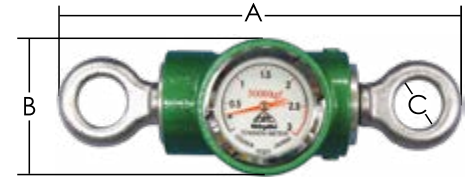

Part No.	Capacity (kN/T)	Graduation (Gauge Increments) (N)	Attachments	Dimensions (mm)			Wt (kg)
				A	B	C	
AS-3	3/0.3	50	Eye-Clevis	110	65	16	0.7
AS-10L	10/1	200	Eye-Eye**	135	65	28	1.2
AS-20L	20/2	500	Eye-Eye**	135	65	28	1.6
AS-30	30/3	500	Eye-Eye	150	80	28	2.0
AS-50	50/5	1000	Eye-Eye	260	95	28	3.0
AS-100	100/10	2000	Eye-Eye	360	100	38	7.2

**1 & 2 Tonne versions also available with Eye-Clevis attachments. Use Part No's AS-10 & AS-20

Mechanical Dynamometers - Dillon

It is used for such diverse jobs as suspended weighing, mounting cables for bridges, adjusting tension on guy wires, tensioning conductor.

- Accuracy $\pm 0.5\%$ of full range
- Max hold feature
- Accurate readings from varying sight lines with fog and scratch resistant dial
- All units include calibration certificate, manual & In-Service Date sticker
- Option of 125mm or 250mm dial size

DILLON



Part No.	Capacity (T)	Kg Division	Ultimate Safety Factor
125mm Dial			
30006-0134	0.5	5	5:1
30006-0159	1.0	10	5:1
30006-0126	2.0	20	5:1
30006-0167	4.0	25	5:1

BLUEMAX USA

Digital Bluetooth Dynamometers - BlueMax

BluemaxUSA dynamometers, the smallest, lightest & most reliable dynamometers. High viewable accuracy - Reliable wireless communication. View on your mobile device. Long life wireless rechargeable battery offering up to 20,000 hrs operation.

- Material: Titanium Ti6Al4V
- Battery: Lithium Polymer
- Accuracy: $\pm 1\%$ at full scale
- Environmental Rating: IP67
- Communications: Bluetooth LE - BLE broadcasting or direct GAT connection up to 100m
- Supplied with hard case

Part No.	Capacity (t)	Range (kg)	Dimensions (mm)	Weight (g)
2000SL	1	in increments of 0.5kg from 25kg	97 x 52 x 17	160
4400SL	2		97 x 52 x 17	160
11000SL	5		120 x 66 x 19	210
22000SL	10		140 x 73 x 28	360



2T unit size comparison to mobile phone



EDJ & EDX Supplied with ABS plastic carry case



Digital Dynamometers - EDJunior - Dillon

Part No. EDJ Series

- Easy to read wide angle 26mm Back-lit LCD with max hold feature
- Soft key interface with programmable functions
- Manufactured from aircraft grade aluminium alloy
- 7:1 safety factor for all capacities

Part No.	Capacity (T) (0.2% Accuracy)	Increments (kgf)	Dimensions (LxWxDmm)	Wt (kg) with Shackles
EDJR-1T	1	1	312 x 127 x 52	1.8
EDJR-2T	2	2	269 x 127 x 75	3.9
EDJR-5T	5	5	289 x 135 x 102	6.5

Other sizes available. Contact TEN for further information

**EDX & EDJ
IP55**



Communicator II

Digital Dynamometers - EDXtreme Red - Dillon

Part No. EDX Series

- High-resolution dot-matrix back-lit LCD display offers large 26mm numbers
- All units include calibration certificate, manual and batteries
- Radio or Hardwire Communication (RS-232 or RS-485)
- Include Remote Configuration, Data Acquisition & Single Point Monitoring of Multiple Units.
- Units available up to 250Ton

Part No.	Capacity (T)	Increments (kgf)	Dimensions (mm)	Wt (kg) with Shackles
EDX-1T*	1	1	269 x 127	3.9
EDX-2T*	2	2	269 x 127	3.9
EDX-5T*	5	5	289 x 135	6.0
EDX-10T*	10	10	291 x 133	17.0
Communicator II - (Includes case & batteries)			241 x 127	2.0

* EDX-Models are supplied Radio Ready and include Rated Shackles



**EDX-Blue
IP68**



Digital Dynamometers - EDXtreme Blue - Dillon

Part No. EDX Blue Series

The EDXtreme Blue is the latest Dillon dynamometer, allowing for wireless use through a Bluetooth® connection with an Android or iOS device. Utilisation of the Dillon EDX free mobile app allows for remote monitoring, data logging and exporting, and remote configuration of the EDXtreme Blue dynamometer.

- 7:1 factor of safety
- Superior strength and corrosion resistance
- Retained hardware
- Environmental Rating: IP68
- Accuracy: 0.1% of capacity up to EDX-10T
- Battery Life: Stand up to 400+ hours

Part No.	Capacity (T)	Increments (kgf)	Dimensions (mm)	Wt (kg) with Shackles
EDXB-1T*	1	1	406 x 178	3.9
EDXB-2T*	2	2	406 x 178	3.9
EDXB-5T*	5	5	406 x 178	6.0
EDXB-10T*	10	10	553 x 279	17.0

* EDX Blue - Models are supplied with Rated Shackles





Non-conductive Aramid Fibre



Recommended for stringing ABC

Socks and Grips, Cable Overhead

Non-Metallic Aramid Socks - Slingco

Part No. Various

Non-metallic cable socks are made of plastic coated Aramid fibres that are light weight, yet much stronger than steel wires. Aramid are a class of heat-resistant and strong synthetic fibres used in aerospace and military applications. These grips are traditionally used in overhead ABC applications or when pulling fibre optic cable.

- Non conductive
- Much lighter yet stronger than steel grips
- Easier to apply and remove
- No frayed wires
- UV Resistant
- Strong enough to last in salt water

Part No.	Cable Range (mm)	UTS (kN)	Mesh Length (mm)	OAL (mm)
ZCS1040	10-20	11.16	552	725
ZCS1022	20-30	15.89	600	696
ZCS1023	30-40	43.84	642	840
ZCS1024	40-50	52.86	523	775
ZCS1179	50-65	70.71	636	817
ZCS1180	65-76	70.71	908	1086
ZCS1181	76-101	70.71	1029	1239

Non-Conductive Nylon Socks - NCG

Part No. Various

- Double or Triple ply
- Soft Eye
- LV models for LV ABC - Single Eye with Alloy Ferrule
- HV models for HV ABC - Double Eye with Alloy Ferrule



Scan or Click to View or Download Grip Inspection Selection & Application

Part No.	Suits	Grip Length (mm)	UTS (kN)	Working Load Limit (kN)
LV225	2x25mm ² LV	600	15	5
LV235	2x35mm ² LV	600	15	5
LV250	2x50mm ² LV	600	15	5
LV295	2x95mm ² LV	600	15	5
LV335	3x35mm ² LV	600	15	5
LV395	3x95mm ² LV	600	25	8.3
LV425	4x25mm ² LV	600	15	5
LV435	4x35mm ² LV	600	15	5
LV450	4x50mm ² LV	600	15	5
LV470	4x70mm ² LV	600	17	5.6
LV495	4x95mm ² LV	800	25	8.3
LV4150	4x150mm ² LV	800	25	8.3
HV335	3x35mm ² HV	800	25	8.3
HV350	3x50mm ² HV	800	25	8.3
HV370	3x70mm ² HV	800	25	8.3
HV395	3x95mm ² HV	900	31	10.3
HV3120	3x120mm ² HV	900	31	10.3
HV3150	3x150mm ² HV	900	31	10.3
HV3185	3x185mm ² HV	900	31	10.3



Scan or Click to View or Download Grip Inspection Selection & Application

Dimensions: The figures shown are indicative only. Fully dimensioned data-sheets are available upon request. Nominal figures/actuals are as per data-sheet with tolerances of +/-5%.

Cable Pulling Grips - Slingco

Part No. ZCS-Range

For the installation of overhead conductors and cable in conduits, ducts and trenches. The MU Type grip's triple-weave construction is ideal for heavy loads.

- Hand-Woven with quality Galvanised Steel
- Perfect for stringing overhead transmission and distribution lines and heavy load pulls of any kind and ideal for new or old conductors
- The flexible eye connects with line pulling swivels for trouble free pulling applications

Key Features

- Heavy duty multi-weave construction
- High strength grip used for heavy duty pulling
- Suitable for bare steel, AL, CU & covered conductor
- Colour coded for easy identification

IDEAL FOR STEEL & AMOKABEL CONDUCTOR

*Type tested on 3/4/2.5 ACSR and 3/2.75 SC/AC & SC/GZ as per AS1154.3-2009 Section 2.3.3 (Mechanical Strength Type Tests)

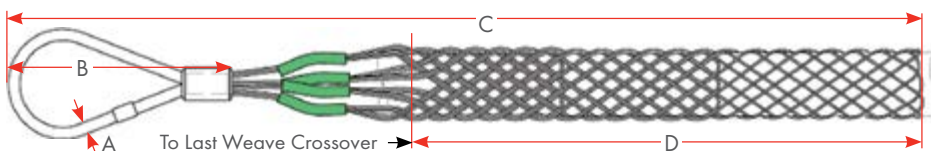

Part No. Colour Code	Conductor Range (mm)	Amokabel Conductor	A (mm)	B (mm)	C (mm)	D (mm)	Breaking Load (T)
ZCS1710	6-12	CCSX25	7	102	965	720	3.17
ZCS1711	12-19	CCSX62	8	127	1263	978	4.76
ZCS1712	19-25	CCSX159	9	156	1537	1162	6.39
ZCS1713	25-32	-	13	165	1909	1470	11.34
ZCS1714	32-38	-	13	165	1725	1291	14.06

Important Note: Ensure fitting instructions are followed and always apply the recommended Steel Band for maximum grip of the conductor
SCAN or CLICK the QR Code above for fitting instruction. Refer Hand Tool Section for Banding Tools & Accessories.

High Strength Cable Grips - Slingco

Part No. ZCS-Range

The strongest grip we produce; can be used for metal wire and synthetic rope pulls. Perfect for overhead transmission and distribution line pulling or any applications with heavy load ratings.

- Double-weave construction
- Colour coded for ease of identification
- Protective shoulders to prevent abrasion
- Suitable for bare or insulated conductors
- Flexible eye compatible with line swivels

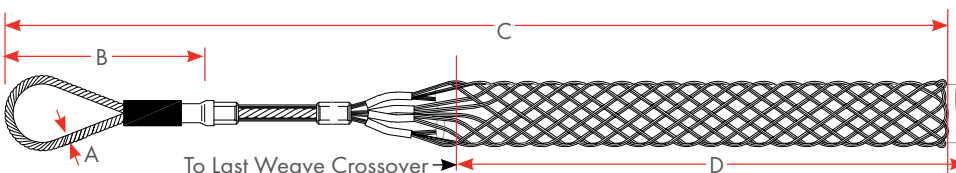

Part No. Colour Code	Rope Diameter (mm)	Conductor Range (mm)	A (mm)	B (mm)	C (mm)	D (mm)	Breaking Load (T)
ZCS1799	6-16	5-10	6	150	975	665	3180
ZCS1800	13-23	9.7-16	9	150	1326	966	6360
ZCS1801	19-28	16-22	11	170	1760	1355	9072
ZCS1802	25-38	22-29	13	175	2041	1558	13955
ZCS1803	32-43	29-35	16	230	2660	2072	21360
ZCS1804	38-53	35-50	18	320	3017	2265	30455

Heavy Duty Large Eye Cable Socks - Tesmec



Part No. Various

- Ideal for underground and overhead work
- Suitable for Transmission & Distribution AL, CU & ST
- Colour coded plastic bands at ferrule to identify range and capacity
- Steel wires with protective finish and alloy ferrule
- Long mesh length provides additional gripping surface area

Part No. GCT001 to GCT030

The head-type temporary mesh sock joints are specifically designed to temporarily connect the aluminium, steel or copper conductor to the pulling rope. They consist of variable pitch steel wires, which effectively distribute the gripping effect on the conductor

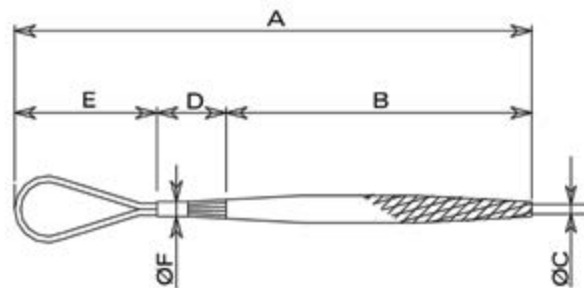

Part No.	Suitable Swivel	Conductor OD C (mm)	Colour	UTS (kN)	A (mm)	B (mm)	D (mm)	E (mm)	F (mm)	Wt (kg)
GCT001	GGT001	8 - 17	Yellow	35	1400	1100	140	160	22	0.7
GCT010	GGT010	17 - 29	Red	85	1700	1360	160	180	28	1.3
GCT020	GGT020	29 - 38	Green	130	1900	1470	200	230	30	2.1
GCT030	GGT020, GGT030	38 - 50	Black	180	2270	1820	200	250	34	2.7

Double Head Socks - Tesmec

Part No. GCT500 to GCT530

The double head-type temporary mesh sock joints are specifically designed to temporarily connect the aluminium, steel or copper conductors. They consist of variable pitch steel wires, which effectively distribute the gripping effect on the conductor

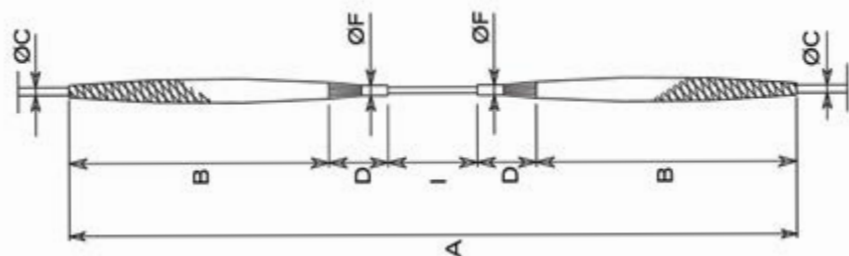

Part No.	Conductor OD C (mm)	Colour	UTS (kN)	A (mm)	B (mm)	D (mm)	OD F (mm)	I (mm)	Wt (kg)
GCT500	8 - 17	Yellow	35	2680	1100	140	22	200	1.15
GCT510	17 - 29	Red	85	3240	1360	160	28	200	2.3
GCT520	29 - 38	Green	130	3540	1470	200	30	200	3.6
GCT530	38 - 50	Black	180	4240	1820	200	34	200	4.8

Determining Working Load Limit is dependent on your application and company/client safety factors

Joists and Swivels

Standard Swivels - Tesmec

Part No. Various

- Swivels for connecting pulling rope to cable sock
- For Overhead or Underground application
- Made from high tensile galvanised and corrosion protected steel
- Chamfered edges allowing smooth passing through rollers or conduit
- Special design can bear high radial loads. Thrust bearings designed to avoid torsion strain accumulation



Part No.	Max Rope Size OD (mm)	Break Load (kN)	Diameter OD (mm)	Overall Length (mm)	Wt (kg)
GGT001	10	70	28	106	0.3
GGT010	13	110	40	143	0.9
GGT020	18	220	54	184	2.1
GGT030	24	360	60	234	3.4
GGT040	28	750	77	322	8.2



Rope to Swivel Connector - Slingco

Part No. Various

Use to connect rope, swivels and other objects. With high strength pin and smooth roller you can safely connect rope without fear of fraying or damage.

- Fitted with high strength pins and smooth rollers
- No fraying or damage to the rope
- Fitted with high strength hex pins

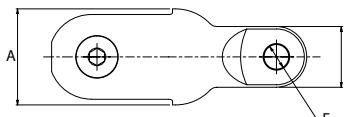
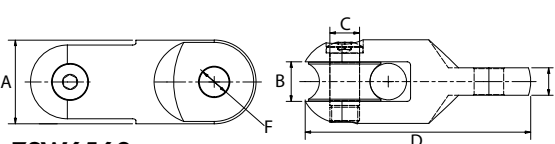
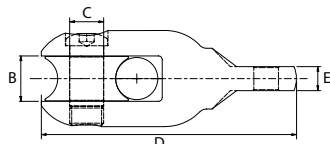
ZSW6559

ZSW6560

Part No.	Safe working load (kg)	Max. rope Dia. (mm)	A (mm)	B (mm)	C (mm)	D (mm)	E (mm)	F (mm)	Wt (kg)
ZSW6559	3170	22.2	50.8	24	18	135	12.7	13.5	1.23
ZSW6560	6800	22.2	50.8	24	18	137	16.7	18	0.91



Rope to Rope Connector - Slingco

Part No. Various

Use to connect rope to rope. With high strength pins and smooth rollers you can safely connect rope without fear of fraying or damage. The rope to rope connector has two rollers to protect rope from becoming frayed.

- Fitted with high strength pins and smooth rollers
- No fraying or damage to the rope
- Fitted with high strength hex pins

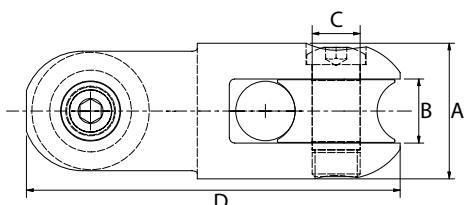

Part No.	Safe working load (kg)	Max. rope Dia. (mm)	A (mm)	B (mm)	C (mm)	D (mm)	Wt (kg)
ZSW6558	6800	22.2	50.8	24	18	140	1.23

TESMEC

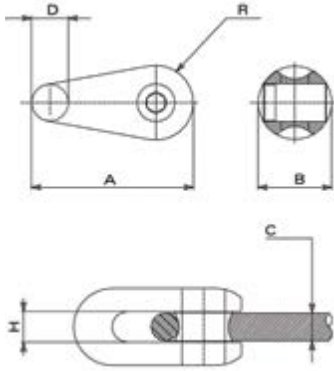

Fixed Joints - Tesmec

Part No. Various

The connectors are specifically designed to connect pilot rope lengths or pulling rope lengths and to pass over the puller or puller-tensioner bull wheels. The special profile minimises the overload on the rope spliced eyes during this passage.

- High tensile steel with galvanised finish, for joining steel draw wire

Part No.	Break Load (kN)	A (mm)	B (mm)	Rope Size C (mm)	D (mm)	H (mm)	R (mm)	Wt (kg)
GFT001	70	59	28	10	15	11	11	0.1
GFT010	110	74	40	13	19.5	14	15	0.3
GFT020	160	91	48	16	20	19	18	0.5
GFT030	220	102	54	18	22	19	20	0.8
GFT040	360	121	60	24	27	26	22	1.0



Anchor Rod Pulling Eye - SPP

Part No: SPP-PE1

- Designed to assist in tensioning guy wires
- Offset eye for 3 tonne hook or shackle, allows easy dead end attachment
- Adjustable wedge allows for maximum rod diameter
- Body and wedge made from ductile iron with high strength bolt
- WLL 5:1 - 26kN
- Breaking Load 133kN
- Suits Anchor Rods 13mm - 32mm OD er

- Weight 2.3kg

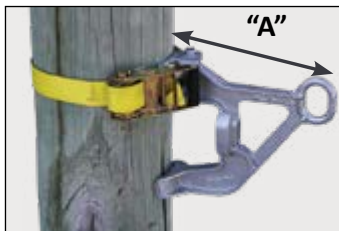

Lifting Gin - Hastings

Part No. 5800-5-V1

- For lifting transformers and heavy objects
- Stamped with load rating (WLL)

- High strength aluminium alloy
- High strength web attachment strap

Part No.	Strap Length (mm)	Dimension "A" (mm)	WLL (kg)	Wt (kg)
5800-5-V1	1100	270	860	4



Cross-Arm Slings - Miller

Part No. Various

- Load Rated Flat Webbing Sling

- Steel "D" Rings both ends

Part No.	Length (mm)	WLL /WLL in Choke (kg)	Wt (kg)
CAS1	1000	750/600	0.65
CAS-680	680	750/600	1.00

Stringing Rollers and Attachment Brackets

Angle Insulator Roller - SPP



This unique angle insulator roller has 2 adjustable angle rollers and 2 support rollers that allow the conductor to be brought in at final installation height and adjusted to any required angle alongside the insulator.

The conductor is fully enclosed at all times during the stringing operation and cannot fall out. When stringing & tensioning is complete, the locking pins are opened and the roller removed, leaving the conductor in its correct position on the insulator.

- The sealed bearing assists smooth running of the conductor.
- The clamps are specially treated with rubber so as not to damage the insulator.
- The roller fits all styles of ceramic insulators. See below table for suitable neck diameters.

SCAN or CLICK for application video



Specifications

Part No.	Insulator Neck diameter range		Max Conductor Diameter (mm)	Conductor Type	WLL (kg)	Weight (kg)
	Min (mm)	Max (mm)				
SPP-1E-AR	46	86	50	AL/CU/ACSR/ST*/ABC/CCT	300	7.4



SPP-AR50-60



SPP-BCR50-60

ABC Rollers - SPP

Hanging style roller

- Suits LV ABC
- Max 50mmOD conductor

Part No.	Roller Material	Roller OD (mm)	WLL (kg)	Wt (kg)
SPP-AR50-60	Aluminium	145	2000	1.7
SPP-BCR50-60	Plastic	175	400	5.0

Cross-arm Roller - SPP

Part No. SPP-CARR-Series

In-line Cross-Arm roller

- Suitable for Wood, Steel & Composite cross-arm
- Ratchet strap attachment
- Rubber mounts will not damage composite material
- Zinc plated mild steel



SPP-CARR-100



SPP-CARR-080

Part No.	Description	Suits Cross Arm (mm)	Wt (kg)
SPP-CARR-080	1 Large Horizontal roller	Wood, Steel & Composite up to 150	4.0
SPP-CARR-100	2 x Vertical & 2 x Horizontal rollers	Wood, Steel & Composite up to 150	5.7

Part No. SPP-TCAR-Series

In-line Cross-Arm roller

- Suitable for Wood cross-arm

- "T" Screw handle
- Zinc plated mild steel



Part No.	Description	Suits Cross Arm (mm)	Wt (kg)
SPP-TCAR-100	2 x Vertical & 2 x Horizontal rollers with "T" Screw handle	Wooden up to 100	4.2
SPP-TCAR-150		Wooden up to 150	6.0

OVERHEAD STRINGING EQUIPMENT

CONTENTS



Universal Stringing Roller - SPP

Part No. SPP-1A

- Suitable for distribution and ABC
- Aluminium sheave
- Lightweight high strength heat treated aluminium
- Versatile attachment fittings include side and bottom tags and top ball socket fitting
- Side gate latch can be locked open
- Sheave is profile machined permitting precise sagging of conductor
- High quality permanently lubricated high temperature precision bearings



Part No. SPP-1A-DI

- Same Specifications as SPP-1A
- Ductile Iron sheave (SPP-1A-DI)
- Ideal for Pulling Steel conductor (e.g. 3/12 Steel) or steel catenary



*Ball Socket



SPP-1A-DI



*Centre Tab

Part No.	Sheave Material	Maximum Conductor OD (mm)	WLL* (kg)	Weight (kg)	Bottom of Groove Diameter (mm)	Overall Height (mm)	Overall Width (mm)
SPP-1A	Aluminium	50	1130	4	110	370	205
SPP-1A-DI	Ductile Iron	50	1130	5	110	370	205

*WLL 1130kg when suspended from ball socket fitting or mounted on centre tab

Universal Roller Bracket - SPP

Part No. SPP-1A-BKT

- Versatile mounting bracket for cross-arms and poles
- Frame made from Cast Aluminium
- Lightweight, easy to install
- Heavy Duty Strap and Zinc Plated Ratchet Assembly
- 3 Mounting holes for various configurations
- Ball pin to secure roller
- Suits SPP-1A & SPP-1A-DI Rollers

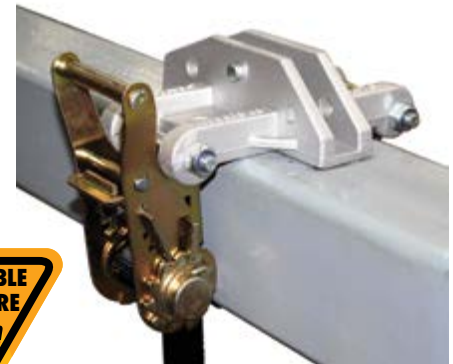

Part No.	Min Cross Arm (mm)	Poles OD (mm)	WLL (kg)	Wt (kg)
SPP-1A-BKT	100 x 100	200-470	Refer Load ratings below*	2.0

SPP-1A & SPP-1A-DI Rollers sold separately to SPP-1A-BKT Roller Bracket

Universal Roller Bracket - Load Rating

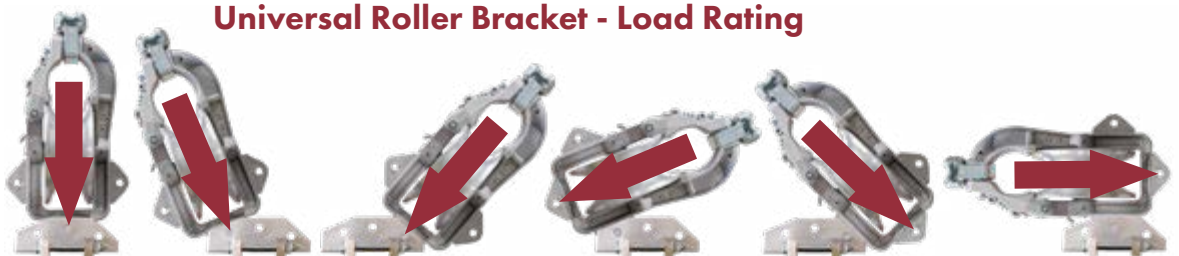
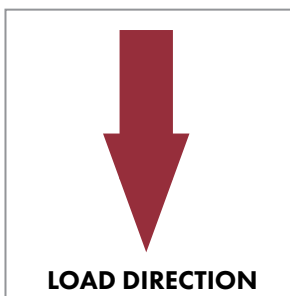

	Vertical	45°	30°	Horizontal	Vertical	Horizontal
SPP-1A-BKT* (WLL - kg)	500	500	500	500	500	500
1A-2A* (WLL - kg)	1130	1130	1130	500	500	500
SPP-1A-CAB* (WLL - kg)	1130	1130	1130	500	500	500

Universal Stringing Roller - SPP

Part No. SPP-1A-SB

- "Pull & Turn" style release gate
- Suitable for distribution & ABC
- Sealed ball bearings



Click to view
Pull & Turn
Release Gate

Shown mounted on
SPP-1A-CAB
Cross Arm Bracket

Part No.	Maximum OD Conductor (mm)	WLL (kg)	Wt (kg)	Bottom of Groove Diameter (mm)
SPP-1A-SB	50	1130	4.1	110

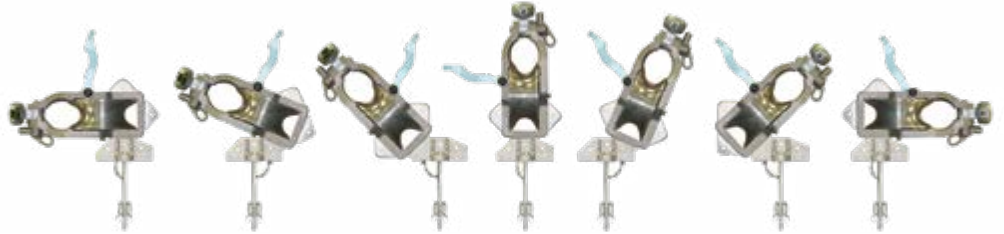

Cross Arm bracket - SPP

Part No. SPP-1A-CAB

- Crossarm mount bracket to suit up to 127mm wide x 152mm deep Cross-arms
- Includes pin for securing universal roller
- NOTE: Refer Load ratings on adjacent page*

Ball Clevis Socket Fittings

Part No. Various



Part No.	BC-70	BEL-70	BHL-70	BYC-120
Description	Ball Clevis	Oval Eye Ball	Safety Hook	Y Ball Clevis
WLL (kN)	70	70	70	70
Weight (kg)	0.55	0.4	0.55	0.85

Tie Top Post Insulator Bracket - SPP

- Manufactured from cast aluminium with urethane jaws
- Easy to operate reverse twist knobs
- Suits maximum insulator 123mm OD neck

Part No.	Max Insulator Throat (mm)	WLL** (kg)	Wt (kg)
SPP-1A-2A	123	Refer Load ratings on adjacent page*	2.6

**Refer Insulator minimum failure load when considering the WLL

Pin Insulator Roller - SPP

Part No. SPP-PIR Series

- Easily lower the conductor into the insulator after stringing
- Simply rotate 90° and loosen tension screw to "open" the rollers
- Prevents workers manually lifting conductor in to place
- Suits Conductors up to 50mm OD
- Moulded PVC inserts prevent damage to insulator

Part No.	Insulator** Throat (mm)	Horizontal Roller (mm)	WLL (kg)	Wt (kg)
SPP-PIR*	55-100	40 OD	250	6.1
SPP-PIR-080*	55-100	50 OD	250	6.5

*SPP-PIR Rollers are designed for use when stringing in a straight run on intermediate poles

**Refer Insulator minimum failure load when considering the WLL



BHL-70 Safety Hook



SPP-PIR





Raising or lowering equipment



Snubbing - Lowering Mains



Rescue



Hand Line and Rope Blocks - Multipurpose

Multipurpose snatch-block - OX BLOCK™

The OX BLOCK™ is a rope snatch-block with an integrated friction bar used for:

- Raising and lowering Equipment (Hauling Line Block)
- Rescue
- Snubbing loads

It allows the rigging professional to handle loads with greater control. When lowering loads, tension is transferred from the worker to the OX BLOCK™.

- The patented OX BLOCK™ replaces standard hand-line blocks, parted blocks and various snatch blocks.
- Has a greater WLL than blocks of similar size.
- When configured with optional pulleys, the OX BLOCK™ can be used to create a 2:1 up to 6:1 mechanical advantage reducing the amount of force needed to lift heavy loads.
- The advantage of the pulleys used by Buckingham is the swivel side plate that allows for quick and easy rope installation without removing the pulley from the connecting device.
- ASME B30 Compliant

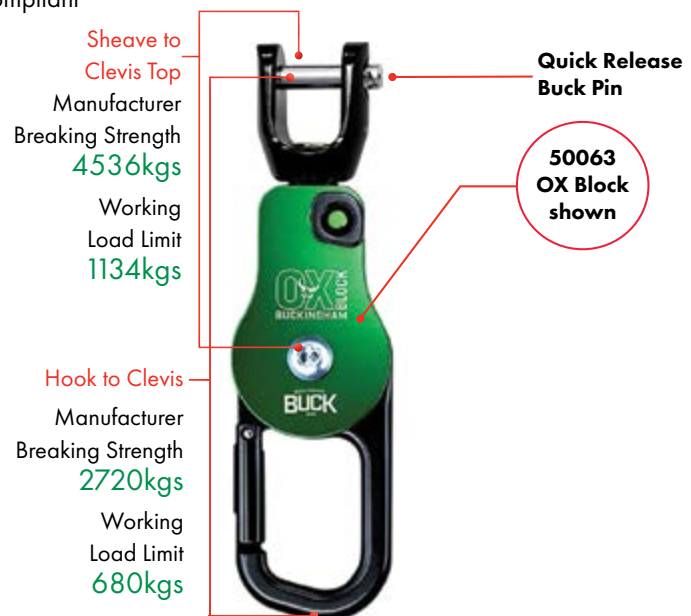

Replace many of the older style pulleys and tackle with the lighter Ox Block system, making rescue, lowering and raising and snubbing workloads easier

Part No.	Attachment	Material	Rope Dia. (mm)	Length (mm)	Width (mm)	Wt (kg)
50061	Swivel Eye	6061 Alloy	16 (max)	267	51	1
50063	Clevis					

Ox Block includes metric markings to comply with relevant Australian Standards



Click or Scan above to see the OX BLOCK™ Video



Our OX BLOCK Clevis Top hand-line assembly features a 1.2m x 19mm adjustable sling, hook and a 16mm hand-line at 24 or 30 meters

Ordering Information

Part No.	Hand-line Length (m)
50062K14-4-80	24
50062K14-4-100	30

For further Ox-Block options and information, contact TEN



SPP-HLB

AHB-4

Hand Line Blocks

Part No. Various

- Hand rope blocks used for hauling and lifting
- Made of high strength aluminum alloy
- Side gate opening with detent pin
- High strength steel rotating swivel hook with safety latch
- Free running sheaves with shielded bearings

High Strength Steel

Part No.	Max Rope Ø (mm)	Sheave Size (mm)	Wt (kg)	WLL (kg)
SPP-HLB	14	75	1.4	560
AHB-4	22	100	2.8	1130



Side gate opening

Single Non-Conductive Hand-line Block

Part No. 3550

- Non-conductive hand-line rope block used for hauling or lifting
- Side gate opening with captive screw pin
- High strength forged steel swivel hook
- 75mm diameter free running sheave with shielded bearings
- Block and sheave constructed of rugged nylon Fibreglass reinforced high dielectric material
- Suits Rope >15.8mmOD
- 450kg WLL
- Weight 0.8kg

Contact TEN for available hand-lines

Hand-line Hook

Part No. 10060

- Used in hauling line assemblies
- Bronze alloy hook
- WLL - 272kg
- Weight - 227g



Service Line Tensioners

Part No. Various

- Used to tension ABC house services
- Made with high quality yachting components
- Sold with detailed tag including WLL

Part No.	Rope Diameter (mm)	Rope Length (m)	WLL (kg)	Pulley System	Wt (kg)
ID015458-ROPEKIT	8	5	100	3:1	2.2
ID017049-ROPEKIT	12	5	300	2:1	2.5



Pole Platform - Steel, Concrete & Wooden

Part No. Various

- For wood, concrete or steel poles
- Steel painted frame and support bar
- Locking chain and zinc plated hardware
- Wooden deck with anti-slip grooving and tread bars
- Suits poles 300mm - 600mm

Part No.	WLL (kg)	Deck Length (mm)	Wt (kg)
KL-2	200	700	8.1
KL-4	200	1100	12.1
KL-15	Chain assembly		3.1

CONTENTS



Pole Handling

Pole Stands - Flat Stack - TEN

Part No. Various

- Foldable for easy storage
- Brushed aluminium
- All stands come with load rating tags and serial numbers
- Reflective tape for improved visibility
- Position locking arm - improved stability
- Safer with reduced pinch points

Part No.	PS-AF-4T-S	PS-AF-4T-L
WLL (kg)	4000	4000
Dimensions (mm)	500 (H) x 100 (D)	850 (H) x 100 (D)
Finish	Aluminium	Aluminium
Weight (kg)	10.4	16.2

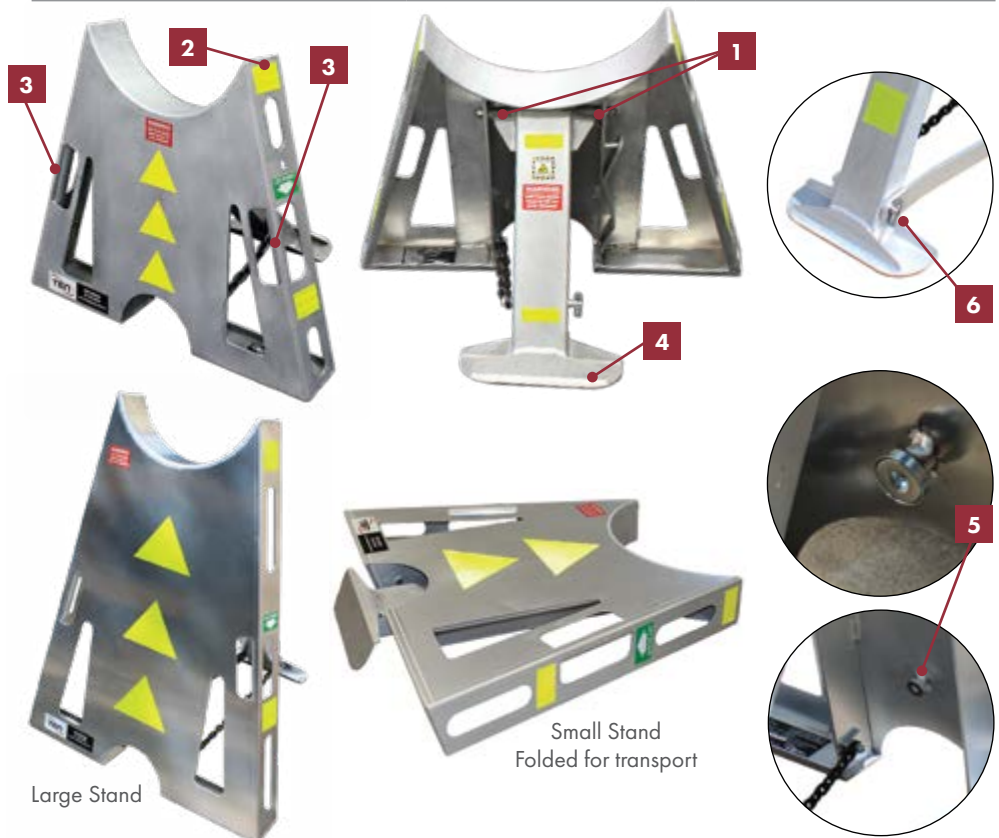

Large Stand

Small Stand
Folded for transport

- 1 Reduction of potential pinch points through design
- 2 Day and night reflective tape for improved customer safety on public sites
- 3 Balanced and ergonomic built in handles for gloved hands
- 4 Large rear foot for stability and load spread
- 5 Magnetic latch for leg stowage. Prevents inadvertent swinging out of leg while maneuvering on site
- 6 Lock leg with positive locking mechanism

Easy storage and portability



Strong & Durable

Pole Stands - Lightweight

Part No. Various

- Lightweight aluminium construction with no moving parts minimises the risk of manual handling injuries
- Powder Coated finish
- Unique data plate on each stand.

Part No.	FSLPSP-01-2	FSTPSP-02
WLL (kg)	4000	4000
Dimensions (mm)	500 (H) x 700 (D)	900 (H) x 1000 (D)
Finish	Powder Coated Yellow	Powder Coated Yellow
Weight (kg)	7.1	7.9

Cant Hooks - Fibreglass Section



See our range of Cant Hooks in the Fibreglass section

Conductor Handling Equipment

Temporary Crossarm - Termination & Intermediate

- Advantages over other temporary crossarms
 - "CAN" be used for Terminations
 - "CAN" be used in HV situations
- Chemically Inert:
 - Cross-Arm will not RUST, ROT or CORRODE
- Lightweight: (15kg)
 - Composite Cross-Arm - Approximately 1/3 the weight of timber
 - Bracket - Manufactured with high strength Aluminium
- Cross-arm provides additional protective layer of insulation (BIL rating 673kV/m)
- Takes 3 time longer to ignite and does not sustain a flame

See Fibreglass Section for full details

Triple Line Lifter - "T" Style - LineWise

The phase lifter is an insulated crane attachment used to support up to three energized lines. The Triple Line Lifter replaces the need for temporary structures and tag lines while giving positive control of the live lines.

Part No. TLL-300

- TLL-300B direct replacement for competitor's Three phase lift assembly
- TLL-300B mounts to material handling jib of bucket truck
- No cross bracing required
- Crossarm is pinned to the mast
 - crossarm can rotate 15 degrees each direction from 0 degrees (in line with the boom) and also 15 degrees each direction from 90 degrees
- 10 minute set up time = 2 lineman and no tools required

Wire holder spacing can be easily adjusted with no tools in 3" increments

Gravity gate for easy capture & release of wire. Wear pads protect the fibreglass

Part No.	Voltage (kV)	Phase spacing Max (mm)	Phase spacing Min (mm)	Capacity per phase / total (kg)	Mounting
TLL-300B	34.5	2286 Outside-Outside	559 Outside-Outside	136 / 408	Bucket truck handling jib
		1143 Centre-Outside	280 Centre-Outside		
TLL-300D	34.5	2794 Outside-Outside	559 Outside-Outside	136 / 408	Digger derrick or crane
		1397 Centre-Outside	280 Centre-Outside		

Triple Line Lifter - Articulated Style - LineWise

Part No. TLL-500A (series 1 & series 2 models)

- Hydraulic articulation, extension & retraction
- Conductor spacing: 2.4 –4.8m
- Quick Attach Insulators & Wire Holders
- Insulator spacing adjustable with torque gun (Series 2)
- Vertical and horizontal construction
- High Strength Steel fabrication
- Holding valves on all cylinders
- Manual override control valve
- Handheld Radio Remote Control
- Installed at ground level
- Unit weight: 524kgs.
- Mounted in skid: 941kgs

Voltage (kV)	Conductors	Phase spacing Max (mm)	Phase spacing Min (mm)	Capacity per phase / total (kg)
33	3	4877 Outside-Outside	2388 Outside-Outside	227 / 680
66		2438 Centre-Outside	1194 Centre-Outside	227 / 680

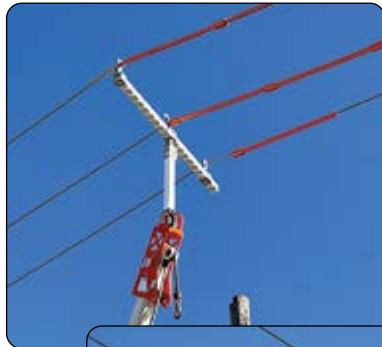

SCAN or CLICK for application video

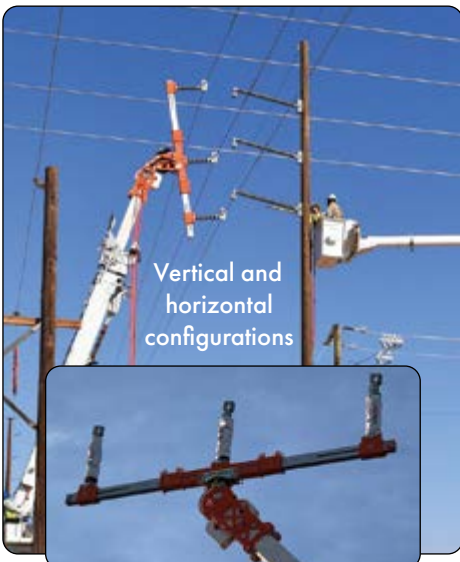

Vertical and horizontal configurations

CONTENTS



Hydraulic Pole Pullers

Pole Puller - Hydraulic - 56T

Part No. PP-60-XHD

- Dual Cylinder Pole Puller
- 600mm hydraulic cylinder stroke
- High capacity, hydraulic powered
- Pulling utility poles up to 700mm diameter
- Force of 56 Tonne
- Grips the pole with cam-action heads with beveled teeth to provide a better grip
- Use with open-centre or closed-centre hydraulic systems
- Fitted with 7.5m hydraulic hose
- Built-in fork pockets, 2 lifting points on the head & high strength alloy chains
- Increased stability due to larger footprint
- Increased gripping capability ensures chain does not slip up pole
- Utilises existing low pressure tool circuit on lifter borer-crane
- Hydraulics: Required flow rate 5-15gpm @ 2,250 psi max.

Performance	Pull 56 Tonne at 155 bar
Maximum Pole Size (mm)	710 Diameter, 2230 Circumference
Cylinder (mm)	Stroke 600
Head (mm)	Chain 2 x 20mm Grade 100
Footprint (mm)	Exterior 1168 x 1168, Interior 711 x 711
Height (mm)	Retracted 1500, Extended 2100
Weight (kg)	680
Lifting Points (mm)	830 x 184 x 1168



Beveled Teeth Provide Better Grip



Pole Puller, Hydraulic 22T - Reliable

Part No. REL-PL-P

The REL-PL-P will make Pole Pulling with a Lifter Borer a thing of the PAST. Reduce damage and potential for injury related to pole pulling. Simple installation and operation.

Kit Includes:

- Hydraulic Cylinder with Flush Face Coupler Set
- Swivel Chain Hook Assembly
- Chain (12.7mm x 1830mm Alloy)
- Base Plate & Back Plate

Operating Pressure (PSI)	2800
Recommended Flow	15-30 lpm
Lift at Max Pressure	22734kg

Part	Wt (kg)
Cylinder	25.85
Base Plate	11.34
Back Plate	11.34
Swivel Chain Hook Assy	16.32
Chain	6.8

Part No. REL-PL-PAD (sold separately)

Optional Base Pad provides a strong, stable surface under soft ground conditions, and distributes the extreme force of the pulling





Transformer Oil Containment

BOB® - ABG

Bigger & Stronger Safety Orange Transformer Containment Bags

Safely Contain, Lift, Transport & Store all sizes of LEAKING TRANSFORMERS

- Helps to reduce preventable spills that release unwanted oils into the environment
- Easy to store on truck solution for safe transport and storage of faulty transformers
- Reduce costs of transporting large steel containers as well as the cost to clean up leaks



PREVENT OIL SPILLS INTO THE ENVIRONMENT



CLICK or SCAN to watch the BOB in action.

BOB® Replacement Pole-Mounted Transformer Bag (Round)

BOB Part No.	Dimensions (m) (D) x (H)	Capacity (kg)	Old Part No.	Dimensions (m) (D) x (H)	Capacity (kg)
BOB-26	0.66 x 0.76	567	PT-22	0.55 x 0.65	635
BOB-32	0.81 x 0.96	630	PT-30	0.75 x 0.90	860
BOB-42	1.07 x 1.22	907	PT-42	1.00 x 1.20	1020

BOB® Replacement Pad-Mounted Transformer Bag (Rectangular)

BOB Part No.	Dimensions (m) (D) x (W) x (H)	Capacity (kg)	Old Part No.	Dimensions (m) (D) x (W) x (H)	Capacity (kg)
BOB-48	1.22 x 1.22 x 0.91	1361	PMT-48	1.20 x 1.20 x 0.90	1360
BOB-60	1.52 x 1.52 x 0.91	1814	PMT-60	1.52 x 1.52 x 0.90	1814

FLEXTRAY® - ABG

A flexible spill tray for the easiest, safest way to transport and store oil filled apparatus

- Lightweight Design For Easy Storage & Setup
- Easily Stored on Truck
- Safely Contain PCB's and Other Contaminants
- Avoid Preventable Spills
- Universal Portable Containment Tray
- Easily Secure Tray To Transformer With Cam Buckles & Webbing
- Recyclable
- Available in 3 Sizes

PREVENT OIL SPILLS INTO THE ENVIRONMENT



CLICK or SCAN to watch the FlexTray in action.



Part No.	Folded Size (mm)	Open Size (mm)	Wt (kg)
CT-084	1067 (L) x 559 (W) x 254	2134 (L) x 2134 (W) x 457 (H)	8
CT-096	1143 (L) x 635 (W) x 305	2438 (L) x 2438 (W) x 457 (H)	14.5
CT-108	1219 (L) x 771 (W) x 381	2743 (L) x 2743 (W) x 381 (H)	16

Pole Setting

Dirt Tarps - Slingco



Slingco's range of heavy-duty, re-usable dirt tarps have been created with safety in mind. Keeping workers out of awkward, injury-prone positions is better for their long-term health and the company's bottom line. Dirt tarps have become a must-have product at utility construction sites.

You can find Slingco Dirt Tarps being used at pole change-outs, transformer terminations, as well as underground gas, telephone, and other underground utility applications.

The Dirt Tarp has the ability to move crushed rock, sand, dirt, wet cement, dig spoils, and other contaminated soil.

- Heavy-duty webbing and lifting loops
- Double stitched for reinforcement and durability
- Simply clean, dry, store, and re-use!
- Compact enough to store on truck when folded



Time saved filling holes, moving materials and cleaning up



SCAN or CLICK to watch tarp in use

Part No.	Size (m)	WLL (kg)	Dirt/Gravel (m ³)
ZLD10792	1.8 x 1.8	1814	2
ZLD10793	2.1 x 2.1	1814	3
ZLD10016	2.4 x 2.4	2268	4
ZLD10015	3.0 x 3.0	2268	6

POLESETTER ROCKBAG

POLESETTER ROCKBAG - ABG

The safest and fastest way to re-set poles and back filling



- 5:1 Safety Factor
- Self-Standing Rugged Design
- Flow Control Discharge Spout
- Quick Fill & Rapid Release
- Top-Lift Safety Rated 5x Capacity
- Compact For Easy Storage
- Reusable & Recyclable



CLICK or SCAN to watch the Polesetter bag in action.

Part No.	Capacity (kg)	Open Size (mm)	Volume (lt)
PS-01	680	610 (D) x 813 (H)	208
PS-02	907	762 (D) x 914 (H)	416



More sizes available Contact TEN

Characteristics

- Extremely high strength
- Light weight
- Abrasion resistant
- Low stretch
- Neutral buoyancy
- Splicable
- Flexible

Applications

- Alternate to wire rope
- Winch lines
- Tow lines
- Rigging lines
- Utility line



- Higher breaking strength
- Abrasion resistance
- Excellent shock absorption
- Better grip
- Minimal elongation
- Durable and ultraviolet stabilized
- Excellent shape retention
- Strength: wet/dry 100%
- Floats/sinks: Floats
- Elongation: Moderate
- Water absorption: None
- Chemical Resistance
 - Acids: Excellent
 - Alkalis: Excellent
 - Oil/Gas: Very Good



Characteristics

- High strength
- High UV resistance
- Flexible & Splicable

Applications

- Winch, Tow & Rigging lines
- Pulling and stringing line

Pulling Rope

ROBUS Dyneema Rope - Hampidjan

Part No. Various

ROBUS rope is an ultra-high strength rope developed to meet the need for light but ultra strong ropes.

ROBUS ropes are made from quality HMPE fibre.

- High performance 12 strand braided HMPE rope
- Can be used everywhere where optimal strength vs diameter is required and temperature is normally below 40°C

Polyester Cover available on request

Part No.	OD (mm)	Wt per 100 m (kg)	Max Break Force (T)
H-54-006*	006	2.3	4.2
H-54-008*	008	3.9	7.0
H-54-0010*	010	7.2	13.1
H-54-0012*	012	9.0	16.3
H-54-0014*	014	10.3	19.5
H-54-0016*	016	13.8	26.0

*Specify Length in meters

Polypropylene Rope - 3 Strand - Hampidjan

Part No. Various

Part No.	OD (mm)	Wt per 100 m (kg) 250m (Coil)	Max Break Force (T)
PPR-12*	12	7.0	2.84
PPR-14*	14	9.0	3.91
PPR-16*	16	12.0	4.90
PPR-18*	18	15.0	5.50
PPR-20*	20	18.0	7.52
PPR-22*	22	22.0	8.45
PPR-24*	24	26.0	10.20
PPR-26*	26	31.0	11.87

*Specify Length in meters

Lifting Rope with Clevis eyes available Contact TEN for further information

Double Braided Hauling Rope - Hampidjan

Part No. DBPR-Series

- Manufactured in Australia with a braided polyester cover over a braided Polyester core
- Ideal for use as winch and tow lines and for pulling cable

Part No.	OD (mm)	Wt per 100 m (kg)	Max Break Force (T)
DBPR-12*	12	11.10	3.49
DBPR-14*	14	13.90	4.36
DBPR-16*	16	18.25	5.75
DBPR-18*	18	22.20	6.98
DBPR-20*	20	27.30	8.59
DBPR-22*	22	33.30	10.48
DBPR-24*	24	41.60	13.10
DBPR-26*	26	46.30	14.56



Meets or exceeds the dry or wet electrical requirements of: IEC 62192:2009
Arc-Flash rated: Resistant to 40 cal/cm² (category 4)

**ARC-FLASH
RATED**



Tag Line & included Storage bag



Live Line Rope



Optional Storage bag for Live Line and Rescue Ropes



Rope Link & included Storage bag



Dielectric Ropes

D.E.W Line™ - Barry

Insulating Live Line Rope offers a unique coating and excellent dielectric properties and can be knotted. This live line rope is designed for performing live work on or near AC or DC energized lines and apparatus.

Features

- Unique insulating properties
- Knottable
- Cleanable and easy to maintain and test
- Exceptionally low leakage current, whether dry or wet
- Protection from high fault current
- High strength
- Low elongation
- Lightweight and low volume
- Fully sealed and hydrophobic
- Smooth surface
- High abrasion resistance
- Easy to deploy
- Excellent resistance to changing weather conditions, UV, corona effect and temperature extremes
- Sealed termination at each end
- Easy storage in optional transport bag with desiccant

Tag Line

Part No. HL-NK1000

Insulating Rope Tool serves as a Fibreglass tool replacement during temporary installations on or near AC or DC energized lines and apparatus.

Ordering Information

PART No.	OD (mm)	WLL (kg)	Standard lengths (m)	Colour
HL-NK1000**	6	90	6.1-9.1-12.2**	Black w/orange terminations

Other lengths, diameters and WLL available. Contact TEN for further information

Live Line Rope

Part No. HL-NP

Insulating Live Line Ropes offers a unique coating and excellent dielectric properties and can also be knotted. This live line rope is designed for performing live work on or near AC or DC energized lines and apparatus.

Ordering Information

PART No.	OD (mm)	Breaking Load (T)	Standard Lengths (m)	Colour
HL-NP2800**	13	2.85*	15-30-45**	Orange
HL-NP4500**	14	4.53*	15-30-45**	Orange

Live Line Rope Link

Part No. HL-NK1900

Insulating Rope link serves as a Fibreglass tool replacement during temporary installations on or near AC or DC energized lines and apparatus.

Ordering Information

PART No.	OD (mm)	WLL (T)	Lengths (m)	Colour
HL-NK1900**	22	3.175	Nominate**	Black

**Nominate Length Required

Other diameters and lengths available. Contact TEN for further information.

Rescue Rope

Part No. HL-NF3400

High Angle Rescue Rope for evacuation of workers in energised fields on AC or DC.



Rescue Rope

Ordering Information

PART No.	OD (mm)	Breaking Load (T)	Length (m)	Colour
HL-NF3400**	12	3.4*	Nominate**	Orange w/tracer

*Reduce the Break Load by 50% when using knots

** Nominate Length Required

Safety Nets

Part No. HL-NK1000C

Insulating safety nets are constructed using Barry's proprietary D.E.W. Line® rope and their specially designed clips. They have excellent dielectric properties and are designed to serve as a safety barrier or guard structure installed on hurdle poles or infrastructures for power lines, road and railway crossings.

Protects and secures apparatus while performing hot/live work under AC or DC condition.

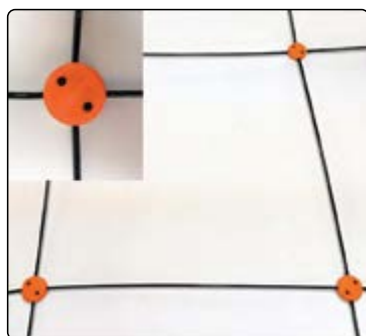

Ordering Information

PART No.	OD (mm)	Mesh Breaking Load (T)	Standard Sizes (m)	Colour
HL-NK1000C	6	2.85	21 x 30.5 21 x 45.7 21 x 61.0	Black Rope with Orange Junction Clips

Other widths, lengths and mesh sizes available. Contact TEN for further information.

The dielectric safety nets are extremely durable and offer reliable dielectric properties similar to those of Fibreglass tools and hot sticks. They are completely jacketed and sealed in order to eliminate contamination of the fibres which could otherwise permanently trap conductive dirt and moisture. They are easy to inspect and maintain.



**Extensive range of Barry Rope Products available
Contact TEN for further information**

Helicopter longlines

Lifting beams

Barry d.E.W. Line® dielectric winch lines

Barry d.E.W. Line® lineman rescue kit with retrievable anchor strap

Insulating - Live Line Rope

Insulating Rope - 3 Strand

Part No. Various

- Dry tested to 100kV/300mm in humid conditions
- To IEC 62 912, European Directive 98/37/EC
- Technical specification HTB-71B-2
- Manufactured under ISO9001 & ISO9002
- Low water absorption coefficient

**Rope Tester also available
See Test and Measurement
section for details**



See Test Section for Rope Tester

Part No.	OD (mm)	Wt per meter (g)	Break Force (kg)
13400-08*	8	30	929
13400-10*	10	50	1421
13400-12*	12	70	2111
13400-14*	14	90	2903
13400-16*	16	120	3483
13400-18*	18	150	4630
13400-20*	20	180	5588

* Specify length in meters

Eye splices available



Petrol Portable Capstan Winch

Portable Petrol Capstan Winch - Docma

Part No. VF900-4

Docma Portable Capstan Winch equipped with the Honda 4-stroke engine
Designed for all your Pulling, Hauling & Lifting projects

Features

- Made in Italy from high quality materials
- Honda 4-Stroke GX50 Engine, meets Australian Emission Standards
- Variable speed controlled by rope tension
- High quality reducer with helical tooth gears

Used For

- Underground Cable Hauling
- Overhead conductor stringing
- Lifting equipment on pole and towers
- Tree lopping and felling, including directional felling
- Ground clearing & firewood collection
- Camping, hunting & 4X4

**LOW NOISE
LOW EMISSION**



Winch Specifications

Part No.	Capacity (kg)			Engine type	Pull Speed (m/pm)	Engine (kw/hp)	Rope		Wt (kg)
	Pulling	Double Rope	Lifting				Size (mm)	Wraps on Drum	
VF900-4	865	1730	200	Honda 4 Stroke GX50	14	1.47/2.0	10 / 12**	4/5	10.85

** 10 and 12mm Double Braid Polyester Hauling Rope available in a variety of lengths.

Winch Mounting Accessories - Docma

Accessory Mount

Part No. VF310500

Utilised to mount all Winch accessories

Vertical Lift/Brake Mount

Part No. VF310503

Set on a pole or tower with Pole Mount VF310501 for controlled lifting

Hook/Sling Attachment

Part No. VF310211

Used in conjunction with a sling to attach winch to pole, tree or tower



Winch Mounting Accessories - Docma (cont.)

Ground Mount

Part No. VF310504

Attached the winch and bolt or clamp to the ground or concrete pad for operating winch at ground level



Hayman Reece Adaptor

Part No. VF310506

Standard Hayman Reece socket adaptor for winch operation from the back or your vehicle



Pole-Tree-Tower Mount

Part No. VF310501

Attach to a Pole, Tower or tree and hook the winch or lift bracket

TESMEC

Part No. PL1150

Performance	
Max pull (kN)	30
Speed at max. pull (km/hr)	1
Max speed (km/hr)	3.2
Pull at max. speed (kN)	10
Hydraulic Transmission	
Closed hydraulic with pull pre-setting system that automatically adjust pulling speed.	

The PL1150 Hydraulic Puller is suitable to string one rope. The bull wheel grooves are made of wear proof thermally treated steel.



MAX PULL

35kN



MAX SPEED

3.6km/h



ROPE DIAMETER

13mm



See "Cable Installation Equipment & Transmission Stringing" sections for further information on TESMEC's range of Stringing Machines

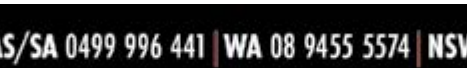
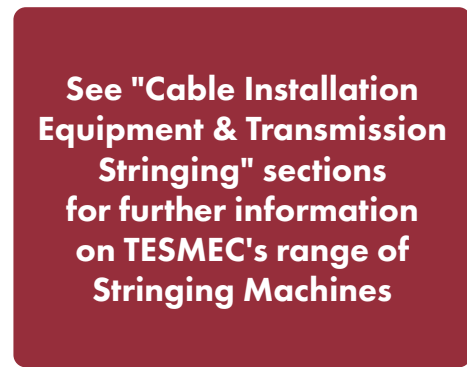

Characteristics	
Bull Wheel dia. (mm)	350
Max. rope dia. (mm)	13
Mass (without rope) (kg)	980
Engine	
Diesel (kW)	19 (26hp)
Cooling System	Water
Electrical System (V)	12
Configuration	
<ul style="list-style-type: none"> • New Digital HMI 127mm (5") display • Negative self-acting hydraulic brake • On board automatic reel winder • Pull recorder & Digital meter counter 	

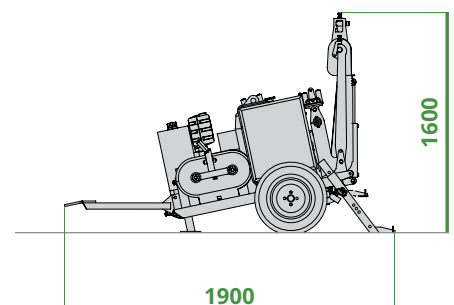

CONTENTS



To Watch the CM3K in action, SCAN or CLICK the QR-Code



Battery Capstan Winches

Battery Capstan Winches - 1360kg - iTOOLco

Part No. CM3K

Ideal for Industrial/Commercial applications. Pulling from remote locations is no longer a challenge. This portable 1360kg puller is intuitively designed to handle all of your day-to-day pulls.

Speed, Versatility, and Performance are all yours with iToolco's Battery Capstan Winch. The built-in capstan switch automatically turns the puller on and off. Simply tug on the rope to start the pull and back off to shut it down.

Delivers dynamic performance in remote locations or areas where power is not yet available.

Powered by Milwaukee Batteries

Versatile Dual Capstan



Part No	Ordering information	Dimensions Collapsed (mm)	Dimensions Extended (mm)	Wt (kg)
CM3K	Winch, Conduit Adaptors & Rack Motor, 2 x Batteries, Charger	914 (W) x 686 (H) x 2120 (L)	914 (W) x 686 (H) x 2900 (L)	62.3
Pull Speed		Max Pulling Capacity (kg)		Pull at Max Speed (kg)
Small Capstan	Large Capstan	1360		682
Up to 15.2m/pm - 1360kg	Up to 32.9m/pm - 682kg			



To Watch the UMP3K in action, SCAN or CLICK the QR-Code



Battery Capstan Winch - 1360kg - iTOOLco

Part No. UPM3K

Ideal for Utility Applications

Includes Tow-bar Mount

Get high-speed performance and a unique set-up with iTOOLco's 3K Utility Puller™.

Designed for quick set-up, the 3K Utility Puller's articulating receiver adapter can be positioned 180 degrees vertically or horizontally at the precise angle needed to get the job done.

With this hardworking puller you can transfer heavy pulling loads to the ground within centimeters of the conduit you're pulling through.

For overhead pulls, line guide rollers keep the rope centered on the capstan.

Powered by Milwaukee Batteries

Versatile Dual Capstan



Part No	Ordering information	Dimensions Collapsed (mm)	Dimensions Extended (mm)	Wt (kg)
UPM3K	Winch, Milwaukee Motor, 2 x Batteries, Charger	508 (H) x 508 (W) x 1900 (L)	508 (H) x 508 (W) x 2900 (L)	74.1
Pull Speed		Max Pulling Capacity (kg)		Pull at Max Speed (kg)
Small Capstan	Large Capstan	1360		682
Up to 15.2m/pm - 1360kg	Up to 32.9m/pm - 682kg			



Battery Capstan Winches - 2727kg - iTOOLco

Part No. CD6K

Ideal for Industrial/Commercial or OH & UG applications. . When 2T is not quite enough and you don't want to drag a big puller around on your vehicle, this iTOOLco winch is the ideal puller.

Speed, versatility, and performance are all yours with iTOOLco's Cordless Cannon 6K™.

This portable 2727kg puller is intuitively designed to handle all of your day-to-day wire pulls.

The built-in capstan switch automatically turns the puller on and off. Simply tug on the rope to start the pull and slack off the rope to shut it down.

Delivers dynamic performance in remote locations or areas where power is not yet available.

**Powered by
Dewalt
Batteries**



To Watch the CD6K in action, SCAN or CLICK the QR-Code



Part No	Description	Dimensions Collapsed (mm)	Powered by	Wt (kg)
CD6K	Winch, Conduit Adaptors & Rack Motor, 2 x Batteries, Charger	1220H x 546W x 546L	Battery operated 4 speed Dewalt motor	62
Pull Speed		Max Pulling Capacity (kg)	Pull at Max Speed (kg)	
Small Capstan	Large Capstan			
Up to 4.9m/pm - 2727kg		2727	1360	



Electric Capstan Winches

Electric Capstan Winch - 5450kg - iTOOLco

Part No. C12K-230

Fully self-contained, compact Cannon 12K™ wire puller has a 6-speed 230V reversible motor.

Designed specifically for easy set up to meet job site demands with all parts store on the puller. No large storage box of parts needed.

When extra extensions are used, the wire puller is capable of pulling out 3.9m of wire from the conduit opening.

This cable puller is easy to maneuver, and can be changed quickly from side pulls to overhead or underground.

iTOOLco's Cannon 12K™ pulls at speeds up to 11m per minute.



**Pulls at
11 m
Per Minute**

Part No	Description	Dimensions Collapsed (mm)	Powered by	Wt (kg)
C12K-230	Winch, Conduit Adaptors, Rack & 230V Motor	1730 (L) x 762 (W) x 1450 (H)	230V motor	183
Pull Speed		Max Pulling Capacity (kg)	Pull at Max Speed (kg)	
Small Capstan	Large Capstan			
Up to 4.5m/pm - 5450kg		5450	2720	



NOTES

A series of horizontal dotted lines spanning the width of the page, intended for taking notes.



TEN Group

The Energy Network (Australia) Pty Ltd | ABN 72 093 052 441

QUEENSLAND

2B, 605 Zillmere Road
ZILLMERE 4034

P +61 7 3212 8999

W www.tengroup.com.au

E salesqld@tengroup.com.au

TEN HIRE

2B, 605 Zillmere Road
ZILLMERE 4034

P +61 7 3212 8999

W www.tenhire.com.au

E hire@tengroup.com.au

NEW SOUTH WALES

Suite F2, Level 1
152-156 Pacific Highway
TUGGERAH NSW 2259

P +61 417 631 443

E salesnsw@tengroup.com.au

VICTORIA

Unit 16, 191-195 Greens Road,
DANDENONG STH VIC 3175

P +61 3 9793 1622

E salesvic@tengroup.com.au

WESTERN AUSTRALIA

4/15 Baile Road
CANNING VALE WA 6155

P +61 8 9455 5574

E saleswa@tengroup.com.au

TASMANIA | STH AUSTRALIA

Unit 19, 15 Stanton Place
CAMBRIDGE TAS 7170

P +61 499 996 441

E salestas@tengroup.com.au

