

OPGW INSTALLATION & SAFETY ON CROSSINGS

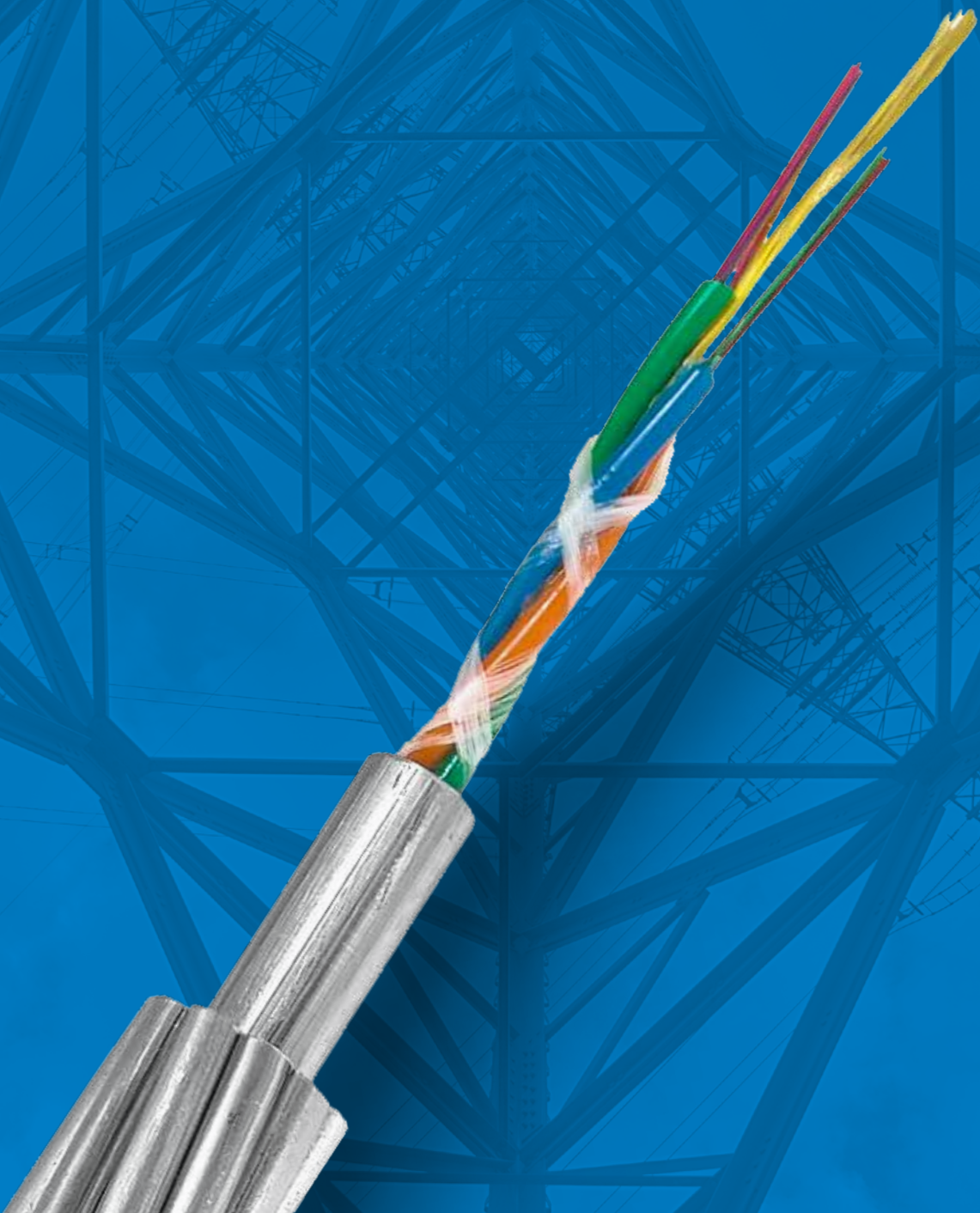



INDEX

MACHINES

CODE	RANGE	LAYOUT	BULL WHEEL DIAMETER	GROOVES NUMBER	ENGINE POWER	
ARS001	3,5 kN	Single	120 mm	6	3,3 kW	4.10
ARS200	15 kN	Single	200 mm	7	13 kW	4.15
ARS403	35 kN	Single	325 mm	7	25 kW	4.20
FRS301	25 kN	Single	1500 mm	5	-	4.25
AFS303	25 kN	Single	1500 mm	5	34 kW	4.30

OPGW ANTI-TORQUE DEVICES AND FIBER OPTIC CLAMP

CODE	
RFF / MOF	4.35

TRACTION MACHINE

CODE	
TMT / TMR	4.40

CRADLE BLOCKS

CODE	
ABR	4.45

OPGW INSTALLATION & SAFETY ON CROSSINGS

High precision and top safety level

Tesmec offers a complete line of machines and equipment dedicated to Earth Wire and OPGW installations and reconductoring.

We can provide a full and customized package for live line OPGW reconductoring; similar equipment can be used as a safety system in case of road and rail crossings.

All the products are designed according with IEC TR 61328, ensuring the top level of safety, reducing all the risks for operators and preventing conductor damages.



OPGW INSTALLATION & SAFETY ON CROSSINGS: OUR VALUE PROPOSITION



PULLER & TENSIONER

Solution for new lines.

The match between Tsmec puller and tensioner is the right choice for stringing a new OPGW or ground wire line.

The main features of the puller - light weight, reliability and multi-functionality - joined with the 1500 capstan diameter of the tensioner are the best solution ensuring high precision and reliable performances.

The grooves are made of high resistance nylon sectors, according to IEC TR 61328. This hard surface has several advantages that prevent damages on the OPGW, the most important are:

- + Low torsional stress resulting in no birdcaging risk.
- + Smooth self alignment of the cable at the bottom of the groove.
- + No need to change conductor reeving direction according to cable formation.



TRACTION MACHINE

One system for two applications.

Traction machine is the best solution for live line replacement of Earth Wire/OPGW with OPGW and safety nets on critical crossing.

The key features of this machine are high speed and pulling capacity that means:

- + Heavy operations, such as safety nets and longer span.
- + Operating times reduction.



PULLER TENSIONER

Reliable reconductoring.

AFS303, in addition to all the advantages related to the hard surface (see the previous box), allows the max. precision level during reconductoring operations:

- + The pull pre-setting system controls the stringing tension with high precision (+5% accuracy).
- + Single drive pinion transmission ensures same speed of the bull-wheels while torque value can be different. This prevents slippage or overloads on the cable.



ORIGINAL BY
TESMEC



ANTI-TORQUE DEVICES

Easy passage.

The combination of the OPGW anti-twisting devices RFF and the clamp for fiber optic MOF model guarantees the best protection from the torque preventing all the risks related to its damage.

RFF is specifically designed to connect the pulling rope with an OPGW: its two arched rods facilitate the overtake of the blocks and two counterweights avoid cable twisting.

The clamp model MOF has special liners shaped on the exact OPGW external diameter.

ARS001

HYDRAULIC PULLER



MAX PULL

3,5 kN



MAX SPEED

2,4 km/h



ROPE DIAMETER

8 mm

DETACHABLE IN 3 PARTS

MINI PULLER



PERFORMANCE *

Max pull	3,5 kN
Continuous pull	2,5 km/h
Max speed	2,4 km/h

* at 20°C and at sea level

HYDRAULIC TRANSMISSION

Closed hydraulic circuit for stepless speed variation in both rotating directions.

CHARACTERISTICS

Bull-wheel diameter	120 mm
Bull-wheel material	ALUMINIUM
Max nylon rope diameter	8 mm
Max Capacity	500 m
Weight (dry)	80 kg

Composed by

Cable level winder, reel modular	23 kg
Puller modular	28 kg
Engine plus pump modular	29 kg
Number of grooves	6
Suitable for	1 rope
Layout	Single

ENGINE

Gasoline	3,3 kW
Cooling system	AIR
Starting system	by handle

CONFIGURATION

Negative self-acting mechanical brake.
Hydraulic dynamometer with set-point and automatic control of maximum pull.
Built-in reel winder with automatic level wind.

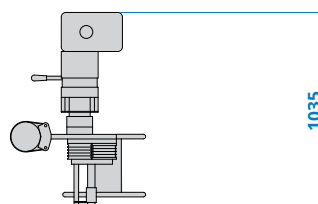
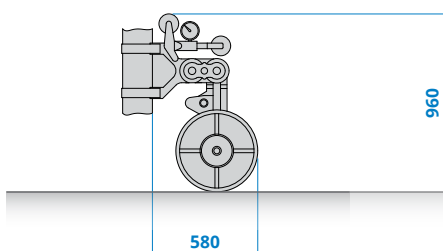

ARS200

HYDRAULIC PULLER



MAX
PULL

15 kN



MAX
SPEED

3,6 km/h



ROPE
DIAMETER

8 mm

MULTI PURPOSE MACHINE

COMPACT DESIGN



ARS200 with ALL112

PERFORMANCE *

Max pull	15 kN
Speed at max pull	0,7 km/h
Max speed	3,6 km/h
Pull at max speed	4 kN

* at 20°C and at sea level

HYDRAULIC TRANSMISSION

Closed hydraulic with pull pre-setting system that automatically adjust pulling speed.

CHARACTERISTICS

Bull-wheel diameter	200 mm
Bull-wheel material	STEEL
Max rope diameter	8 mm
Weight (dry)	500 kg
Number of grooves	7
Suitable for	1 rope
Layout	Single

ENGINE

Gasoline	13 kW (18 hp)
Cooling system	AIR
Electrical system	12 V

CONFIGURATION

Negative self-acting hydraulic brake.
Hydraulic dynamometer with set-point and automatic control of maximum pull.
On board automatic reel winder with level wind, for mod. BOF370 for 500 m of Ø 8 mm rope.

AVAILABLE DEVICES

ALL102	Pulling rope locking device when capstan is used (compulsory for EC market)
ALL105	Rigid axle and towing bardetachable, for manual towing
ALL107	Capstan (diameter=220 mm equipped with guide rope rollers)
ALL111	Swivel guide rope roller.
ALL112	Trailer 80 km/h. EC type-approved for road circulation with hook Ø 40 mm and lighting system.

ARS200 with ALL111

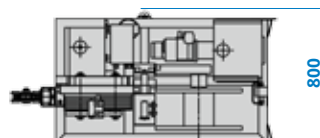
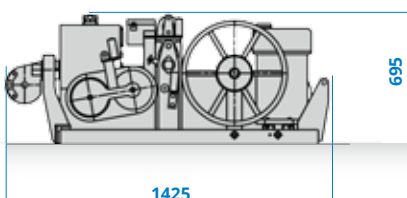

ALL112

Certified Quality System
ISO 9001:2015

Certified Environmental System
ISO 14001:2015

Certified Health & Safety System
ISO 45001:2018

Pictures & drawings can be different according to technical specifications - updating programme variations without notice are possible.

ARS403

HYDRAULIC PULLER



MAX PULL

35 kN



MAX SPEED

3,6 km/h



ROPE DIAMETER

13 mm

MULTI PURPOSE MACHINE

AVAILABLE FOR ROAD USE



PERFORMANCE *

Max pull	31/35 kN*
Speed at max pull	1,2 km/h
Max speed	3/3,6 km/h*
Pull at max speed	12 kN

* at 20°C and at sea level

HYDRAULIC TRANSMISSION

Closed hydraulic with pull pre-setting system that automatically adjust pulling speed.

CHARACTERISTICS

Bull-wheel diameter	325 mm
Bull-wheel material	STEEL
Max rope diameter	13 mm
Weight (dry)	980 kg
Number of grooves	7
Suitable for	1 rope
Layout	Single

*According to emission level

ENGINE

	19 kW(26 hp) 25 kW (34 hp)*
Diesel	
Cooling system	WATER
Electrical system	12 V

CONFIGURATION

Negative self-acting hydraulic brake.
Hydraulic dynamometer with set-point and automatic control of maximum pull.
Control instruments for hydraulic system and Diesel engine.
Rigid axle 30 km/h.
Mechanical front stabiliser.
Grounding connection point.
On board automatic reel winder with level wind, suitable for mod. BOF010 and BOF020.
Reel shaft AXR001.
Pull pre-setting system.

AVAILABLE DEVICES

ALL110	Underground cable pulling attachment.
ALL111	Swivel guide rope roller.
ALL112	Trailer 80 km/h. EC type-approved for road circulation with hook Ø 40 mm and lighting system.
AXR001	Extra shaft.
DLR300	Electronic pull and speed recorder.



DLR300



ALL112

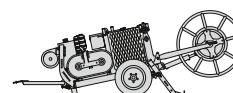
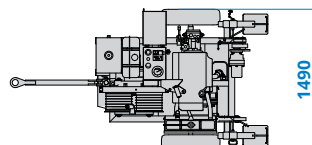
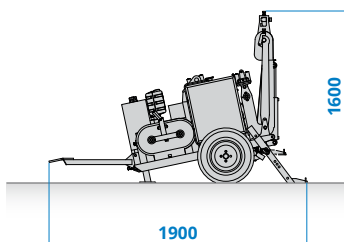

ALL111

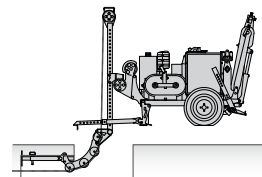

ALL110

Pictures & drawings can be different according to technical specifications - updating programme variations without notice are possible.



FRS301

HYDRAULIC TENSIONER



MAX
PULL

25 kN



MAX
SPEED

5 km/h



ROPE
DIAMETER

36 mm

DESIGNED FOR OPGW

PRECISE, GREEN AND SILENT

PERFORMANCE *

Max tension 25 kN

Max speed 5 km/h

* at 20°C and at sea level

HYDRAULIC TRANSMISSION

Half closed hydraulic circuit with tension presetting system.

CHARACTERISTICS

Bull-wheel diameter 1500 mm

Bull-wheel material NYLON

Max conductor diameter 36 mm

Weight (dry) 1950 kg

Number of grooves 5

Suitable for 1 conductor

Layout Single

CONFIGURATION

Negative self-acting hydraulic brake.
Hydraulic dynamometer.
Mechanical meter counter.
Rigid axle 30 km/h.

Gearbox with 3 operating positions:
+ Neutral position (with free bull-wheels for conductor loading and unloading).
+ Low tension position (1,5 ÷ 5 kN).
+ Nominal tension position.

Mechanical front stabiliser.
Grounding connection point.

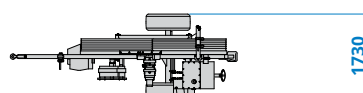
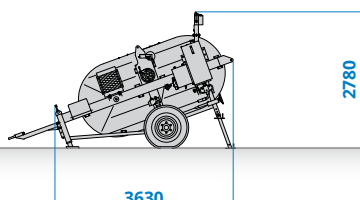

AFS303

HYDRAULIC PULLER TENSIONER



MAX PULL

25 kN



MAX SPEED

4,25 km/h



CONDUCTOR DIAMETER

36 mm

DESIGNED FOR OPGW

ELECTRONIC CONTROLS

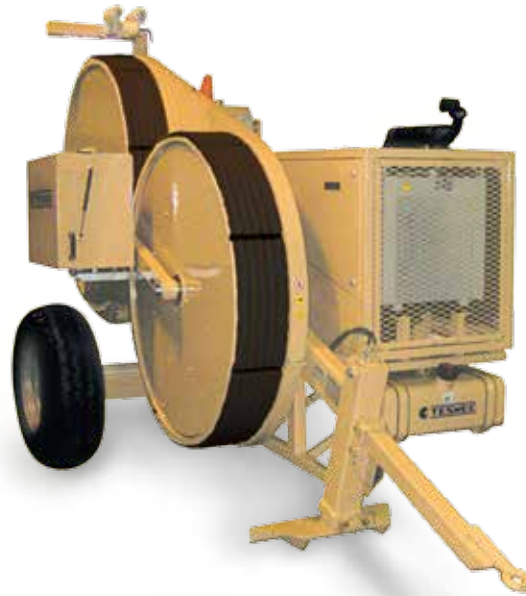

PERFORMANCE *

Max pull / tension	25 kN
Speed at max pull / tension	2,5 km/h
Max speed	4,25 km/h
Pull / tension at max speed	15 kN

* at 20°C and at sea level

HYDRAULIC TRANSMISSION

Closed hydraulic with pull pre-setting system that automatically adjust pulling speed.

CHARACTERISTICS

Bull-wheel diameter	1500 mm
Bull-wheel material	NYLON
Max conductor diameter	36 mm
Max rope diameter	10 mm
Weight (dry)	2700 kg
Number of grooves	5
Suitable for	1 rope / conductor
Layout	Single

ENGINE

Diesel	34 kW (46 hp)
Cooling system	WATER
Electrical system	12 V

CONFIGURATION

Negative self-acting hydraulic brake.
Hydraulic dynamometer with set-point and automatic control of maximum pull.
Digital meter counter.
Control instruments for hydraulic system and Diesel engine.
Rigid axle 30 km/h.
Hydraulic power pack to control 1 drum stand with hydraulic motor or 1 reel winder

Gearbox with 3 operating positions:
+ Neutral position (with free bull-wheels for conductor loading and unloading).
+ Low tension position (1 ÷ 5 kN).
+ Nominal tension position.

Hydraulically front stabiliser.
Grounding connection point.

AVAILABLE DEVICES

ALL005	Hydraulic power for compressor.
ALL037	Preheating device up to -30°C.
ALL051	Cable remote control kit (AXC005 not included)
ALL059	Radio remote control kit (AXH007 not included)
ALL071	Hydraulic rope / conductor clamp for reel / drum change operations.
ALL089	Electronic connection and synchronization between machines.

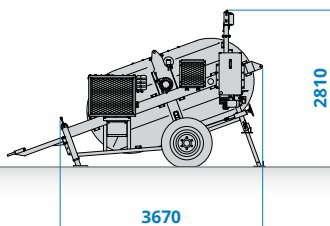

3670

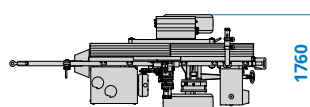

1760



AXC006



AXH007



RFF

OPTICAL GROUND WIRE (OPGW) ANTI-TORQUE DEVICES - RFF

SHAPED FOR SMOOTH OPERATIONS
SWIVEL INCLUDED



ORIGINAL BY
TESMEC

MOF470

CLAMP FOR FIBER OPTIC - MOF

RIGID DESIGN AVOIDS DAMAGES ON FIBER
INTERCHANGEABLE AND MACHINED JAWS

RFF

MODELS	DIMENSIONS		WORKING LOAD	WEIGHT	FOR PULLEYS Ø
	L	R			
RFF001	3900	330	10 KN	60 Kg	400 mm 500 mm 650 mm
RFF010	4300	500	10 KN	63 Kg	800 mm 1000 mm

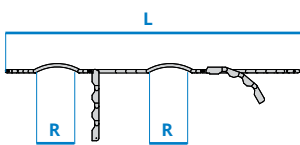

MOF470

PERFORMANCE

Working load 10 kN

CHARACTERISTICS

Diameter range 6÷23
Weight 4 Kg
Material Hot forged steel

CONFIGURATION

Aluminium interchangeable jaws part number GTRXXX: conductor diameter to be specified on order.

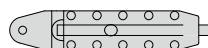
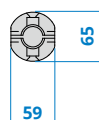
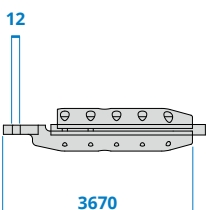

TMT020

TRACTION MACHINE

- HIGHEST TRACTION FORCE AVAILABLE
- CAN BE PULLED BACK IN CASE OF STOP
- UP TO 1000 M RANGE WITH 2 REMOTES

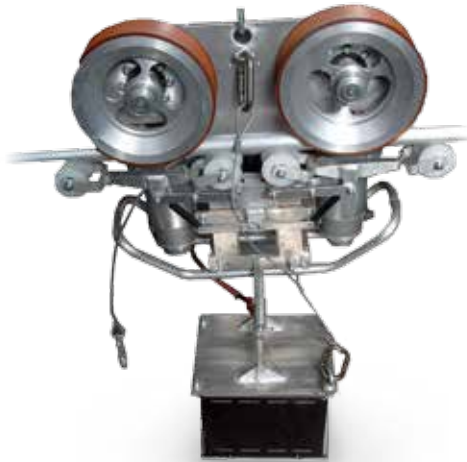

TMT020

TMR030

RECOVERY DEVICE

- AUTOMATIC LOCKING SYSTEM
- DRAG THE TRACTION MACHINE TO FINISH THE SPAN

TMT020

PERFORMANCE

Max traction speed	33 m/min
Max traction force	110 kg
Max slope	20°

CHARACTERISTICS

Weight	55 kg
Robot weight	40 kg
Battery weight	15kg
Two electrical motors	24 V
Conductors diameter range	10÷46 mm
Material	ALUMINIUM alloy
It can cross mid-span joint up to CH=60	
Vulcanized wheels	

REMOTE CONTROL

Two compact radio remote control units with double push-button transmission. Device operative range up to 1000 (m).

AVAILABLE DEVICES

ALL304 Extra battery.

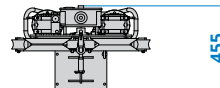
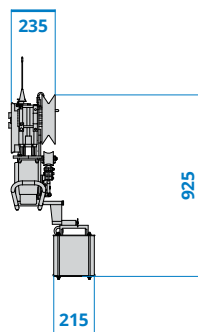
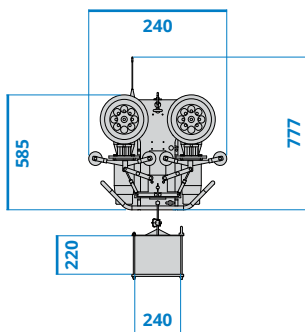

RADIO REMOTE CONTROL

TMR030

CHARACTERISTICS

Max weight	40 kg
Wheels material	NYLON
Detachable ballasts for easy lifting	

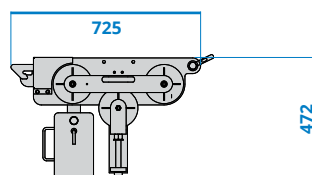

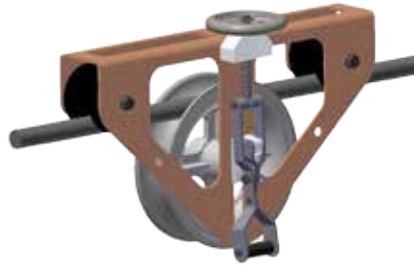
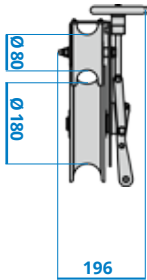
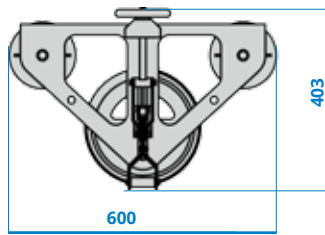

ABR058

BRAKING DEVICE

LIGHT AND COMPACT

ALLOWS THE FINAL RECOVERY OF THE CRADLES

PERFORMANCE

Working load 1,5 kN

CHARACTERISTICS

Weight 4,5 kg

Conductors diameter range 10+30 mm

Wheels material nylon

Frame material ALUMINIUM

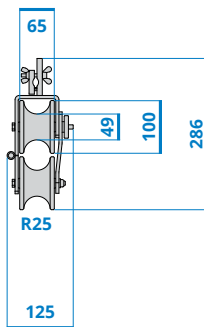
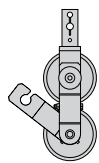

ABR053

CRADLE BLOCK

LIGHT AND EASY

ADJUSTABLE FOR DIFFERENT DIAMETERS

PERFORMANCE

Working load 1 kN

CHARACTERISTICS

Weight 1,4 kg

Rollers material NYLON

Frame material ALUMINIUM

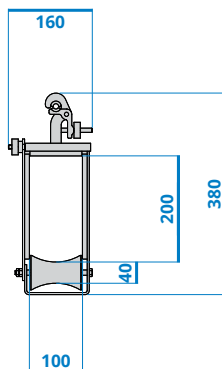

ABR045

CRADLE BLOCK

SUITABLE ALSO ON MIDSPAN JOINTS

ADJUSTABLE FOR DIFFERENT DIAMETERS

PERFORMANCE

Working load 2 kN

CHARACTERISTICS

Weight 2 kg

Rollers material NYLON

Frame material Galvanized STEEL

Internal surface covered by nylon plates

ABR064

CRADLE BLOCK

SUITABLE ALSO ON MIDSPAN JOINTS
ADJUSTABLE FOR DIFFERENT DIAMETERS

PERFORMANCE

Working load 2 kN

CHARACTERISTICS

Weight 1,9 kg

Rollers material NYLON

Frame material Alluminium.
Connection made of steel

Internal surface covered by nylon plates

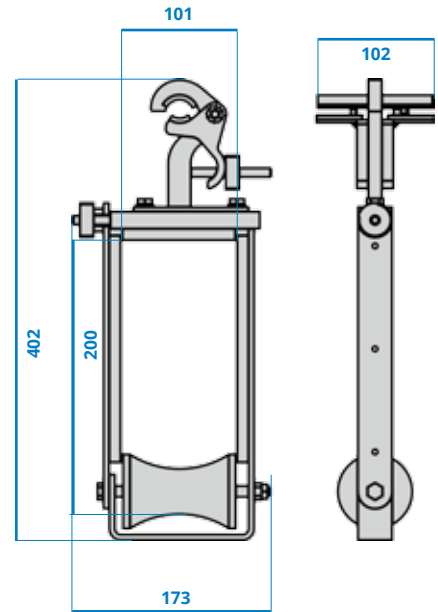

ABR059

CRADLE BLOCK

COUNTERWEIGHT FOR EASY ROTATION
QUICK OPEN/CLOSE SYSTEM

PERFORMANCE

Working load 2 kN

CHARACTERISTICS

Weight 2 kg

Roller material NYLON

Frame material Galvanized STEEL

Internal surface covered by nylon plates

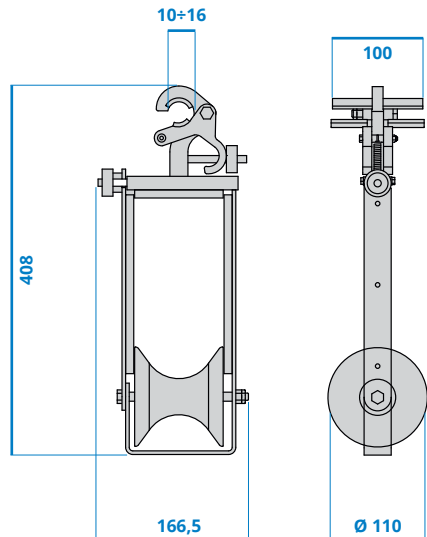

ABR021

CRADLE BLOCK

EARTH WIRE GROUNDED DURING THE OPERATIONS

QUICK LOCKING SYSTEM FOR GUIDE ROPE

PERFORMANCE

Working load 2 kN

CHARACTERISTICS

Weight 1,8 kg

Rollers material NYLON

Frame material Galvanized STEEL

Internal surface covered by nylon plates

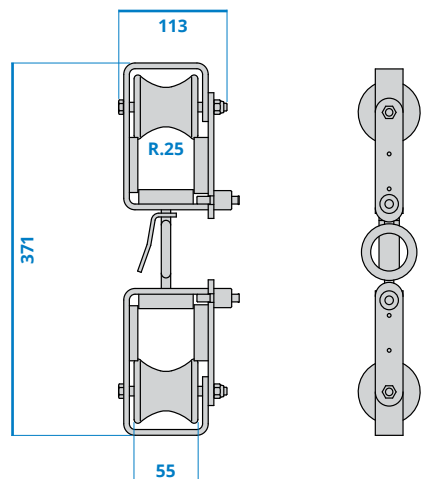

SUGGESTED METHODOLOGY WITH ABR021

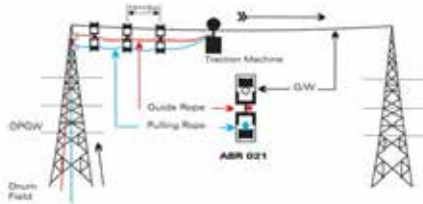

1

Installation of the cradle block ABR021 by the guide rope pulled by traction machine.

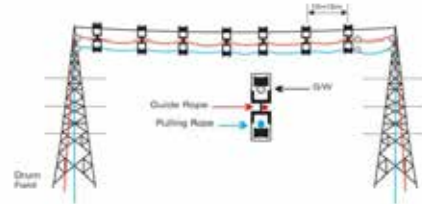

2

The ABR021 move on the existing ground wire by using the upper roller; the pulling rope is laid out at the same time on the lower roller.

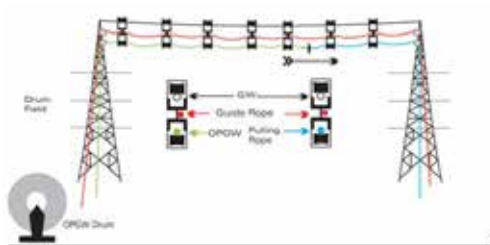

3

The OPGW is pulled by the pulling rope on the lower rollers.

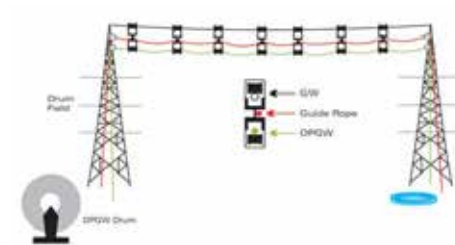

4

All the OPGW is laid out on the lower roller and all the pulling rope is removed.

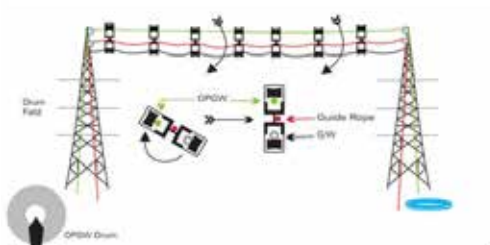

5

All the ABR021 are rotated upside down in order to have the OPGW in the final position.

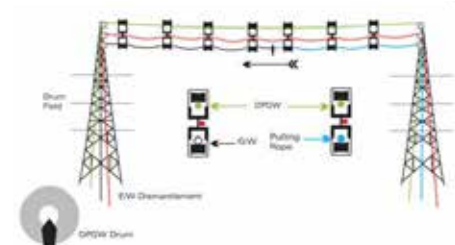

6

The G.W. is removed pulling back the rope on the lower rollers.

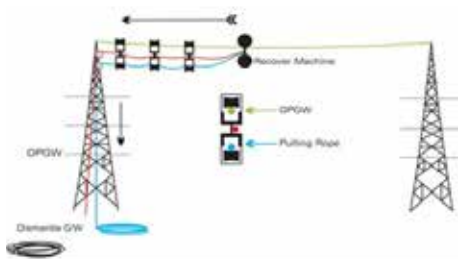

7

All the ABR021 are removed by the guide rope pulled by hands or winch, with minimum sag ensured by the breaking device.

