



- Wire Grips, Socks & Swivels
- Cable Pullers & Winches
- Underground Trench, Corner & Manhole Rollers
- Conduit Proving & Cleaning
- Cable Pulling Lubricant
- Duct Rodders
- Cable Stand & Reel Rollers

## **CABLE INSTALLATION EQUIPMENT**

## CABLE INSTALLATION EQUIPMENT - TABLE OF CONTENTS

<b>Joints and Swivels</b> .....	<b>B4</b>	<b>4-Way Cable Tray Roller - Current Tools</b> .....	<b>B13</b>
Standard Swivels - Tesmec .....	B4	<b>Straight Cable Tray Roller - Current Tools</b> .....	B13
Breakaway Swivels & Replacement Pins - DCD .....	B4	<b>Radius Cable Tray Roller - Current Tools</b> .....	B13
Rope to Rope Connector - Slingco .....	B4	<b>Sheaves and Guides - Hook Style</b> .....	<b>B14</b>
Quick Links .....	B5	Hook Type Sheaves - Current Tools .....	B14
<b>Cable Socks and Grips</b> .....	<b>B5</b>	Right Angle Twin Yoke Sheave - Current Tools.....	B14
Heavy Duty Underground Cable Socks - Tesmec .....	B5	Triangle Sheave Cable Guide- Current Tools .....	B14
Heavy Duty Large Eye Cable Socks - Tesmec .....	B5	Radius Twin Yoke Sheaves - Current Tools.....	B14
Heavy Duty Cable Socks - NCG.....	B5	<b>Duct / Conduit Rodders</b> .....	<b>B15</b>
Lace-up Offset Eye - NCG.....	B6	Traceable Duct Rodder - 4.5, 6, 9 & 11 mm - SPP .....	B15
Lace-up Double Eye - NCG.....	B6	<b>Conduit Cleaning - Wire Brushes and Squeegees</b> .....	<b>B16</b>
Standard Duty Cable Socks - NCG .....	B6	Wire Brushes - SPP .....	B16
Triplex Socks - NCG .....	B7	Rubber Conduit Cleaner - SPP .....	B16
Non-Metallic Aramid Socks - Slingco.....	B7	Rubber Lubricant Spreader - SPP.....	B16
<b>Rollers - Underground</b> .....	<b>B8</b>	<b>Conduit Proving Mandrels</b> .....	<b>B17</b>
Flat Trench Roller - SPP.....	B8	DUCT Proving Mandrels - SPP .....	B17
Flat Trench / Cable Tray Roller - SPP.....	B8	<b>Conduit Blowing</b> .....	<b>B18</b>
Flat Trench Roller - SPP.....	B8	Electric Blower Kit.....	B18
Raised Trench Rollers - SPP .....	B8	Condux Power Dart Blower.....	B18
Raised Trench Rollers - Nylon - Lancier .....	B8	Line Carriers - Rubber .....	B19
Corner & Curve Rollers - SPP .....	B9	Line Carriers - Plastic .....	B19
Corner Rollers - SPP .....	B9	Foam Carriers .....	B19
Corner Roller - SPP.....	B9	Chute Carriers.....	B19
Trench Feed In Rollers - SPP .....	B10	Accessory Bag.....	B19
Manhole Roller Guides - SPP .....	B10	Poly Blowing Line.....	B19
<b>Sheave, Cable Feeding - Lockable</b> .....	<b>B10</b>	<b>Cable Installation &amp; Handling Equipment</b> .....	<b>B20</b>
Feeding Sheave Guide with rollers - SPP .....	B11	Drum Jack Stands - Scissor - SPP .....	B20
<b>Conduit Slippers &amp; Bell-Mouths</b> .....	<b>B11</b>	Real Jacks™ Drum Stand - iTOOLco.....	B21
Bellmouths Lockable - SPP .....	B11	Jack Rack™ For Real Jacks - iTOOLco.....	B21
Conduit Slipper Guides - SPP.....	B11	Real Tender™ Rope Tender - iTOOLco .....	B22
<b>Rollers - Cable Tray</b> .....	<b>B12</b>	Real Spool™ - iTOOLco.....	B22
Box Style Cable Tray Roller - SPP .....	B12	Real Pallet Jack™ - iTOOLco .....	B22
Cable Tray Roller - SPP .....	B12	Real Big Jack™ - iTOOLco .....	B23
4-Way Cable Tray Roller - SPP .....	B12	Real Axles™ - iTOOLco.....	B23
90° Cable Tray Trapping Roller - iTOOLco.....	B12	<b>Material Handling Equipment</b> .....	<b>B24</b>
Cable Tray Roller - iTOOLco .....	B12	iToolco All Jack™ - iTOOLco .....	B24
Cable Tray Threaded Rod Mount - iTOOLco.....	B13		

### CABLE INSTALLATION EQUIPMENT - TABLE OF CONTENTS

<b>Cable Drum Handling Equipment</b> .....	<b>B25</b>	<b>Battery Capstan Winches</b> .....	<b>B38</b>
A Frame Cable Drum Stands .....	B25	Battery Capstan Winch - 1360kg - iTOOLco .....	B38
Reel Roller - Current Tools .....	B25	Battery Capstan Winch - 1360kg - iTOOLco .....	B38
Reel Roller - Current Tools .....	B25	Battery Capstan Winch - 2720kg - iTOOLco .....	B39
Cable Reel Roller - Current Tools .....	B25	<b>Electric Capstan Winch</b> .....	<b>B39</b>
Cable Pusher - Lancier .....	B26	Electric Capstan Winch - 5450kg - iTOOLco .....	B39
Electric Cable Feeder - Current Tools .....	B26	<b>Winches Accessories</b> .....	<b>B40</b>
<b>Rope - Overhead and Underground</b> .....	<b>B27</b>	Tripod For 3K and 6K Pullers - iTOOLco .....	B40
Telstra - Parramatta Hauling Rope .....	B27	<b>Running Line Tension Gauge</b> .....	<b>B40</b>
High Strength Pulling Rope - ROBUS .....	B27	Running Line Tension Gauge - Safe Pull - iTOOLco .....	B40
Double Braided Hauling Rope - Hampidjan .....	B27	<b>Electric Drill Operated Capstan Winch</b> .....	<b>B41</b>
3 Strand Polypropylene Rope - Hampidjan .....	B27	Drill Operated Cable Puller - 454kg - Current Tools .....	B41
<b>Cable Pulling Lubricant</b> .....	<b>B28</b>	<b>Battery Operated Capstan Winch</b> .....	<b>B41</b>
J Lubricant - Polywater .....	B28	Battery Cable Puller - 1500kg - Current Tools .....	B41
J Front End Pack™ Lubricant - Polywater .....	B28	<b>Capstan Winches and Accessories</b> .....	<b>B42</b>
PR Lubricant - Polywater .....	B29	Capstan Winches - 454kg - Chance .....	B42
LZ Lubricant - Polywater .....	B29	Petrol Winch - Honda 35cc 4-Stroke - Chance .....	B42
<b>Cable Pull Planning Software - Polywater</b> .....	<b>B30</b>	Electric Winch - 230V AC - Chance .....	B42
Pull-Planner™ 4.0 .....	B30	Hydraulic Winch - 700bar (10,000psi) - Chance .....	B42
<b>Lubricant Pump / Applicator</b> .....	<b>B31</b>	Rope Lock Device - Chance .....	B43
Lubricant Pump - Polywater .....	B31	Universal Mounting Bracket - Chance .....	B43
<b>Conduit / Duct Adhesive</b> .....	<b>B31</b>	Chain Clamp - Chance .....	B43
BondDuit - Polywater .....	B31	Swivel Base Truck Mount - Chance .....	B43
<b>Conduit / Duct Sealant Systems</b> .....	<b>B32</b>	Swivel Base Truck Mount & Hitch Mount - Chance .....	B43
AFT Sealant System - Polywater .....	B32	Foot Switch - Hydraulic - Chance .....	B43
FST Sealing System - Polywater .....	B33	All Purpose Mounting Bracket - Chance .....	B43
FST-250KIT1 Duct Sealant - Polywater .....	B33	Mounting Accessories - Docma .....	B44
FSTBP™ Duct Sealant Burst Pack - Polywater .....	B33	<b>Petrol Capstan Winch</b> .....	<b>B44</b>
FST MINI Duct Sealant - Polywater .....	B33	Portable Petrol Capstan Winch - Docma .....	B44
<b>Hydraulic Pullers</b> .....	<b>B34</b>	<b>Petrol Drum Winch</b> .....	<b>B45</b>
15kN Hydraulic Puller - Tesmec .....	B34	Portable Petrol Drum Winch - Docma .....	B45
30kN Hydraulic Puller - Tesmec .....	B34	Capstan & Drum Winch Accessories - Docma .....	B45
35kN Hydraulic Puller - Tesmec .....	B35		
70kN Hydraulic Puller - Tesmec .....	B35		
30 & 50kN Battery Puller - Tesmec .....	B36		
70kN Hydraulic Puller - Tesmec .....	B36		
30kN Hydraulic Puller - Tesmec .....	B37		
50kN Hydraulic Puller - Tesmec .....	B37		

## TESMEC



### Joists and Swivels

#### Standard Swivels - Tesmec

##### Part No. Various

- Swivels for connecting pulling rope to cable sock
- For Overhead or Underground application
- Made from high tensile galvanised and corrosion protected steel
- Chamfered edges allowing smooth passing through rollers or conduit
- Special design can bear high radial loads. Thrust bearings designed to avoid torsion strain accumulation

Part No.	Max Rope Size OD (mm)	Break Load (kN)	Diameter OD (mm)	Overall Length (mm)	Wt (kg)
GGT001	10	70	28	106	0.3
GGT010	13	110	40	143	0.9
GGT020	18	220	54	184	2.1
GGT030	24	360	60	234	3.4
GGT040	28	750	77	322	8.2

## DCD Design & Manufacturing Ltd.



#### Breakaway Swivels & Replacement Pins - DCD

##### Part No. Various

- Ensure fibre optic or coaxial is not pulled in excess of rating
- Break loads from 90kg to 800kg
- Replacement pins available
- Contact TEN with your job specifications.

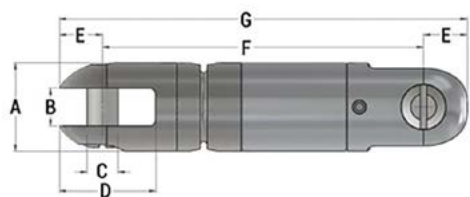

Part No.	Dimensions (mm)							Pin WLL (kg)	Pin Type*	Wt (g)
	A	B	C	D	E	F	G			
00550-005	15.9	7.1	4.7	17.4	6.3	69.8	82.5	307	A	80
00550-010	22.2	9.5	7.9	24.6	11.1	80.9	103.2	455	B	190
00550-020	31.8	13.5	10.3	32.5	13.5	114.3	141.3	1818	C	550

\*See Below

#### Replacement Pin kits



Part No. (10 Pins)	Break Point +/- 10% (kN)	Colour Code	Part No. (10 Pins)	Break Point +/- 10% (kN)	Colour Code	Part No. (5 Pins)	Break Point +/- 10% (kN)	Colour Code
Type A (Swivel 00550-005)			Type B (Swivel 00550-010)			Type C (Swivel 00550-020)		
00555-002	0.88	White	00535-002	0.88	White	00555-013	6.09	White
00555-0034	1.51	Red	00535-004	1.77	Yellow	00555-018	8.00	Green
00555-004	1.77	Yellow	00535-006	2.66	Orange	00555-020	8.89	Blue
00555-0045	2.00	Blue	00535-008	3.55	Grey	00555-027	12.01	Black
00555-006	2.66	Orange	00535-010	4.44	Red	00555-036	16.01	Yellow
00555-007	3.00	Black				00555-040	17.79	Red

## slingco



#### Rope to Rope Connector - Slingco

##### Part No. Various

Use to connect rope, swivels and other objects. With high strength pins and smooth rollers you can safely connect rope without fear of fraying or damage. Connectors have high strength hex pins. The rope to rope connector has two rollers to protect rope from becoming frayed.

- Fitted with high strength pins and smooth rollers
- No fraying or damage to the rope
- Fitted with high strength hex pins

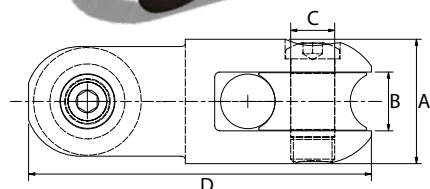

Part No.	Safe working load (kg)	Max. rope Dia. (mm)	A (mm)	B (mm)	C (mm)	D (mm)	Wt (kg)
ZSW6558	6800	22.2	50.8	24	18	140	1.23



### Quick Links

- Suitable for connection of rope to rope, socks, pulling eye or accessories
- Zinc Plated Steel

Part No.	Diameter (mm)	Rope Capacity(mm)	Break Load (T)	OAL (mm)
MRGOZ08.0	8	17.5	3.25	88
MRGOZ10.0	10	20.5	5.00	105
MRGOZ12.0	12	23.5	6.25	124
MRGOZ16.0	16	29.5	12.50	161



### Cable Socks and Grips

#### Heavy Duty Underground Cable Socks - Tesmec

- Suitable for single and multiple core underground cables
- Longer socks give extra pulling force - larger surface area gives better grip
- Steel wires with protective finish and alloy ferrule offering durability and longevity

Part No.	Conductor OD Ø (mm)	Length (mm)	UTS (kN)	Wt (kg)
GCL180	46-60	1600	50	2.0
GCL194	61-80	1800	80	2.5
GCL200	81-100	2000	100	3.0
GCL210	101-140	2000	100	3.5

#### Heavy Duty Large Eye Cable Socks - Tesmec

- Ideal for underground and overhead work
- Suitable for AL, CU & ST
- Colour coded plastic bands at ferrule to identify range and capacity
- Steel wires with protective finish and alloy ferrule
- Long mesh length provides additional gripping surface area

Part No.	Suitable Swivel	Conductor OD Ø (mm)	Colour	UTS (kN)	Mesh Length (mm)	Wt (kg)
GCT001	GGT001	8 - 17	Yellow	35	1100	0.7
GCT010	GGT010	17 - 29	Red	85	1360	1.3
GCT020	GGT020	29 - 38	Green	130	1470	2.1
GCT030	GGT020, GGT030	38 - 50	Black	180	1820	2.7

#### Heavy Duty Cable Socks - NCG

- Suitable for heavier cable hauling
- Soft eye for fitting in tight spaces
- Made from durable galvanised wire and swagged with an aluminium alloy ferrule.



Part No.	To suit cable O.D (mm)	Grip Length (mm)	Min Breaking Load (kN)	Working Load Limit (kN)
CHD1006	6-11	350	8	2.6
CHD1010	10-14	350	15	5.0
CHD1014	14-19	400	20	6.6
CHD1019	19-28	500	37	12.3
CHD1028	28-40	600	54	18.0
CHD1040	40-55	800	62	20.6
CHD1055	55-75	900	80	26.6
CHD1075	75-95	1000	180	60.0
CHD1095	95-120	1000	215	71.6
CHD1120	120-150	1800	287	95.0
CHD1150	150-190	1800	287	95.0

### Lace-up Offset Eye - NCG

Part No. Various

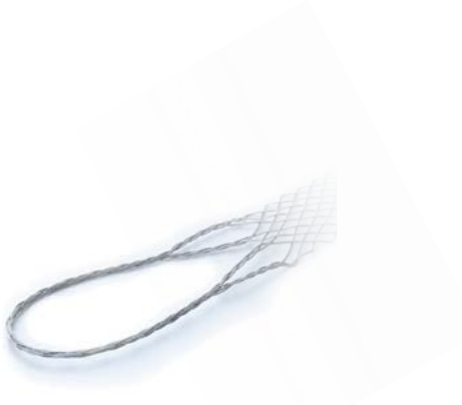

Part No.	Size Range (mm)	Grip Length (mm)	Ultimate Tensile Strength (kN)	Unit Weight (kg)
S1014	14-19	500	9	0.07
S1019	19-28	600	15	0.13
S1028	28-40	800	24	0.26
S1040	40-55	900	35	0.50
S1055	55-75	1000	62	1.00
S1075	75-95	1200	98	1.90
S1095	95-120	1400	98	2.90
S1120	120-150	1600	141	4.60
S1150	150-190	1800	141	5.18

### Lace-up Double Eye - NCG

Part No. Various

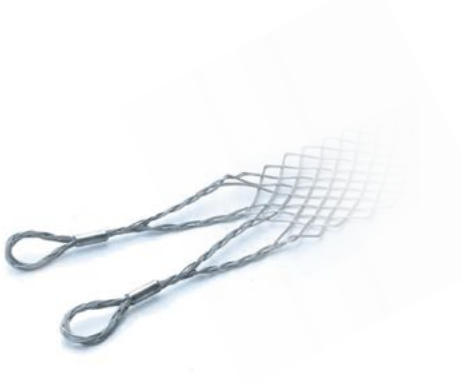

Part No.	Size Range (mm)	Grip Length (mm)	Ultimate Tensile Strength (kN)	Unit Weight (kg)
SA014	14-19	500	9	0.07
SA019	19-28	600	15	0.13
SA028	28-40	800	24	0.26
SA040	40-55	900	35	0.50
SA055	55-75	1000	62	1.00
SA075	75-95	1200	98	1.90
SA095	95-120	1400	98	2.90
SA120	120-150	1600	141	4.60
SA150	150-190	1800	141	5.18

### Standard Duty Cable Socks - NCG

Part No. Various



- Suitable for general hauling applications
- Soft eye for fitting in tight spaces
- Made from durable galvanised wire and swagged with an aluminium alloy ferrule.

Part No.	To suit cable OD (mm)	Grip Length (mm)	Min Breaking Load (kN)	Working Load Limit (kN)
C1006	6-12	350	5	1.6
C1010	10-14	350	5	1.6
C1014	14-19	400	9	3.0
C1019	19-28	500	15	5.0
C1028	28-40	600	24	8.0
C1040	40-55	800	35	11.0
C1055	55-75	900	62	20.0
C1075	75-95	1000	98	32.0
C1095	95-120	1200	133	44.0
C1120	120-150	1400	187	62.0
C1150	150-190	1600	283	94.0

### Triplex Socks - NCG

**Part No. Various**

- Three socks swagged into a single eye
- For hauling multiple and Triplex cables

**All references of 3:1 safety factors are a guide only, consult your work practices**



Part No.	To suit cable OD - each leg (mm)	Grip Length (mm)	UTS (kN)	Working Load Limit (kN)
C1019X3-1000	19-28	1000	15	5
C1028X3-1000	28-40	1000	24	8
C1040X3-1000	40-55	1000	35	11



### Non-Metallic Aramid Socks - Slingco

**Part No. Various**

Grips are traditionally used in, but not limited to overhead ABC applications or when pulling fibre optic cable.

- Non conductive
- Much lighter yet stronger than steel grips
- Easier to apply and remove
- No frayed wires = no wire cuts or contusions
- UV Resistant
- Strong enough to last in salt water

**Ideal for light & Fibre-optic cables**

**Non-conductive Aramid Fibre**



Part No.	Cable Range (mm)	UTS (kN)	Mesh Length (mm)	OAL (mm)
ZCS1040	10-20	11.16	552	711
ZCS1022	20-30	15.89	600	724
ZCS1023	30-40	43.84	642	1245
ZCS1024	40-50	52.86	523	1245

Larger sizes available - Contact TEN for details

SCAN or CLICK to View or Download Grip Inspection Selection & Application



**Determining Working Load Limit is dependent on your application and company/client safety factors**



## Rollers - Underground

### Flat Trench Roller - SPP

#### Part No. Various

- Flat trench roller with 140mm nylon or aluminium roller
- Can be pinned on side for corner bends
- Galvanised finished frame
- Replacement nylon and aluminium rollers available

Part No.	Roller Material	Max cable Dia. (mm)	WLL (kg)	Dimensions (mm)			Wt (kg)
				Length	Width	Height	
SPP-2A-140	Nylon	150	500	330	170	180	1.2
SPP-2A-140A	Aluminium	150	1000	330	170	180	2.6

### Flat Trench / Cable Tray Roller - SPP

#### Part No. Various

- Zinc plated frame
- Nylon and Aluminium rollers available
- Legs can be attached for cable tray / ladder work
- Replacement rollers available

Part No.	Roller Material	Max cable Dia. (mm)	WLL (kg)	Dimensions (mm)			Wt (kg)
				Length	Width	Height	
SPP-3A-140	Nylon	150	500	210	260	150	2.2
SPP-3A-140A	Aluminium	150	1000	210	260	150	3.2

### Flat Trench Roller - SPP

#### Part No. SPP-2A-FTR-205

- Quality aluminium roller complete with bearings
- Galvanised steel frame
- Replacement rollers available

Part No.	Roller Material	Max cable Dia. (mm)	WLL (kg)	Dimensions (mm)			Wt (kg)
				Length	Width	Height	
SPP-2A-FTR-205	Aluminium	195	1000	410	280	230	11

### Raised Trench Rollers - SPP

#### Part No. SPP-2A-RTR

- Quality aluminium roller complete with bearings
- Galvanised steel frame
- Can be arranged over existing cables in trench
- Replacement rollers available

Part No.	Roller Material	Max cable Dia. (mm)	WLL (kg)	Dimensions (mm)			Wt (kg)
				Length	Width	Height	
SPP-2A-RTR	Aluminium	150	1000	290	230	260	2.6

### Raised Trench Rollers - Nylon - Lancier

#### Part No. 14211

- Lightweight and impact resistant
- Can be secured and connected using anchor pins (SPP-PIN)
- Maintenance free sealed ball bearings to stop water and dirt ingress
- Frame made of hard wearing polypropylene



Easily stackable

Part No.	Max Load (kg)	Max Cable (mm)	Dimensions (mm)			Wt (kg)
			Length	Width	Height	
14211	500	132 od	345	229	195	2.2





### Corner & Curve Rollers - SPP

#### Part No. Various

- Solid construction trench roller guides
- Provisions to peg units down and join units together
- Supplied with internal bearings
- Zinc plated finish
- Aluminium Replacement rollers available

SPP-2D-4C90

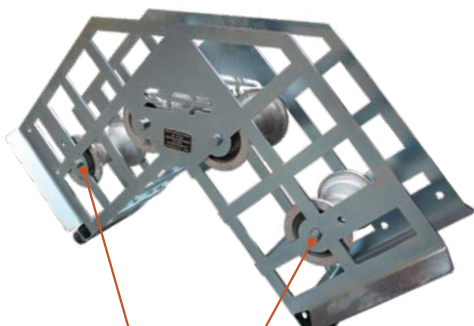

Versatile 90° four corner roller with dual radius capabilities by simply moving bolts to other positioned holes on frame

Part No.	Dimensions (mm)	Angle	Bend Radius (mm)	No. of Rollers	Weight (kg)	Max. Cable OD (mm)
SPP-2D-4C90	700 (L) x 170 (W)	90°	350, 600 & 700	4	22.5	150
SPP-2D-3C45	550 (L) x 170 (W)	45°	500	3	13.0	150
SPP-2D-4C45	800 (L) x 170 (W)	45°	900	4	14.0	150



SPP-2D-3C45

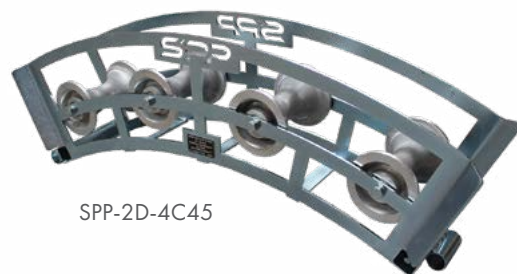

SPP-2D-4C45

### Corner Rollers - SPP

#### Part No. Various

- Trench cable laying corner roller/ trench roller
- Corner guide trench roller
- 1 x Horizontal & 2 x Vertical 60mmOD rollers
- Easily pinned together with star pickets or pins
- 1000kg WLL
- Inverted model also available (SPP-2B-TCR-IN)



SPP-2B-TCR

SPP-2B-TCR-IN

Part No.	WLL (kg)	Dimensions (mm)	Wt (kg)
SPP-2B-TCR	1000	450 (L) x 300 (W) x 310 (H)	12.0
SPP-2B-TCR-IN			14.0

### Corner Roller - SPP

#### Part No. SPP-2B-TCR-205

- Trench cable laying corner roller/ trench roller
- Corner guide trench roller
- 1 x Horizontal & 2 x Vertical rollers



Part No.	Roller Material	Max cable Dia. (mm)	WLL (kg)	Dimensions (mm)			Wt (kg)
				Length	Width	Height	
SPP-2B-TCR-205	Aluminium	195	1000	570	340	340	28

# CABLE INSTALLATION EQUIPMENT

## CONTENTS



SPP-2B-1000



SPP-2B-2x45



SPP-2B-FIR-45



SPP-MRG-1



SPP-MRG-3

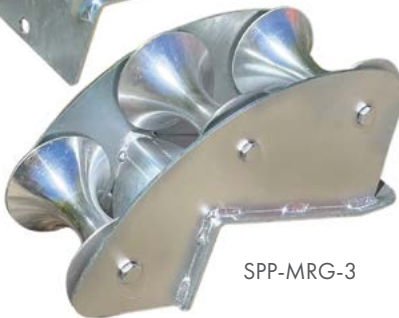

## Trench Feed In Rollers - SPP

### Part No. Various

- Feed-in roller guides for underground applications
- Sealed roller bearings
- All units have fixing points

Part No.	Roller & Frame	Roller Length (mm)	Dimensions (mm)			Wt (kg)
			Length	Width	Height	
SPP-2B-1000	Zinc Plated Steel	1000	1105	220	125	15.71
SPP-2B-2X45	Zinc Plated Steel	2 x 600	1040	220	520	14.7

### Part No. SPP-2B-FIR-45

- Feed-in roller guides for underground applications
- Sealed roller bearings

Part No.	Roller Material	Max cable Dia. (mm)	WLL (kg)	Dimensions (mm)			Wt (kg)
				Length	Width	Height	
SPP-2B-FIR-45	Zinc Plated Steel	195	500	1050	600	450	22

## Manhole Roller Guides - SPP

### Part No. Various

- Right angle corner to assist with laying cables into manholes and cable pits
- Anchoring points in base plates if required
- 140mm aluminium rollers

Side profile  
SPP-MRG-2

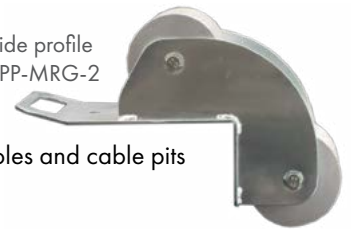

Part No.	Roller Configuration	Bend Radius (mm)	Wt (kg)
SPP-MRG-1	Single Fixed	-	6.5
SPP-MRG-2	Double Fixed	260	8.5
SPP-MRG-3	Triple Fixed	320	12.7
SPP-MRGP-3	Triple Pivoting	320	13.0

## Sheave, Cable Feeding - Lockable

### Part No. Various

- Made from Zinc Plated Steel with Aluminium Roller
- Split design allows easy removal after cable installation
- Designed to suit Cable Exit or Entry
- Lockable to conduit by expansion screw



Part No.	Neck OD (mm)	Suits Conduit ID (mm)	Split Feature	Dimensions (mm)	Wt (kg)
SPP-LFS-080	74	80	Hinged	375 (L) x 190 (W) x 160 (H)	4.15
SPP-LFS-100	98	100		365 (L) x 190 (W) x 190 (H)	5.30
SPP-LFS-125	118	125		390 (L) x 195 (W) x 200 (H)	6.05
SPP-LFS-150	138	150		380 (L) x 225 (W) x 220 (H)	6.60
SPP-LFS-200	190	200		460 (L) x 310 (W) x 300 (H)	14.85

### Feeding Sheave Guide with rollers - SPP

#### Part No. Various



Lockable feeding sheaves with 90 degree bend also available - contact TEN for details

Part No.	Description	Max Cable Dia. (mm)	Dimensions (mm)	Wt (kg)
SPP-SRG080-4R	Lockable multiple roller guide for 80mm Telstra and electrical conduit	80	360 x 200 x 170	5.2
SPP-SRG100-4R	Feeding sheave guide with 4 x tubular rollers for 100mm conduits	100	380 x 220 x 180	6.5
SPP-SRG125-4R	Feeding sheave guide with 4 x tubular rollers for 125mm conduits	125	390 x 230 x 260	7.0
SPP-SRG150-4R	Feeding sheave guide with 4 x tubular rollers for 150mm conduits	150	390 x 260 x 280	7.9

### Conduit Slippers & Bell-Mouths

#### Bellmouths Lockable - SPP

##### Part No. Various

- Made from Zinc Plated Steel
- Split design allows easy removal after cable installation
- Designed for cable entry applications
- Allows multi-direction entry into the conduit



Part No.	Neck OD (mm)	Suits Conduit Diameter (mm)	Split Feature	Dimensions (mm)	Wt (kg)
SPP-BM-050E	42	50 Electrical	Dual Wingnut	255 (L) x 120 (W) x 115 (H)	1.1
SPP-BM-050T	48	50 Telco		255 (L) x 130 (W) x 115 (H)	1.3
SPP-BM-063E	48	63 Electrical		255 (L) x 140 (W) x 115 (H)	1.3
SPP-BM-063T	60	63 Telco	Hinged	250 (L) x 117 (W) x 110 (H)	1.3
SPP-BM-080	74	80		250 (L) x 130 (W) x 140 (H)	1.6
SPP-BM-100	98	100		250 (L) x 177 (W) x 155 (H)	2.8
SPP-BM-125	118	125		250 (L) x 200 (W) x 165 (H)	3.4
SPP-BM-150	138	150		250 (L) x 220 (W) x 175 (H)	3.8
SPP-BM-200	190	200		300 (L) x 297 (W) x 260 (H)	9.4

#### Conduit Slipper Guides - SPP

##### Part No. Various

Cable slippers protect cables from sharp corners of conduit during laying. They are robust and economical. Zinc plated finish.



Part No.	Description	Dimensions (mm)	Conduit Nom. OD (mm)	Bending Radius	Wt (kg)
SPP-CS-080	Conduit slipper guide for 80mm conduit	465 x 90 x 150	80	-	1.3
SPP-CS-100	Conduit slipper guide for 100mm conduit	560 x 110 x 180	100	150	2.5
SPP-CS-125	Conduit slipper guide for 125mm conduit	720 x 140 x 230	125	200	4.9
SPP-CS-150	Conduit slipper guide for 150mm conduit	750 x 160 x 250	150	270	5.3
SPP-CSL-080	Conduit lockable slipper guide for 80mm conduit	410 x 160 x 250	80	150	2.5
SPP-CSL-100	Conduit lockable slipper guide for 100mm conduit	550 x 190 x 340	100	200	4.6
SPP-CSL-125	Conduit lockable slipper guide for 125mm conduit	680 x 220 x 410	125	270	6.8
SPP-CSL-150	Conduit lockable slipper guide for 150mm conduit	720 x 250 x 450	150	270	7.2

# CABLE INSTALLATION EQUIPMENT

## CONTENTS



## Rollers - Cable Tray

### Box Style Cable Tray Roller - SPP

**Part No. SPP-3A-100**

- Quick mount box style cable tray roller
- 42mm x 100mm roller



### Cable Tray Roller - SPP

**Part No. SPP-3A**

- Quality aluminium or Nylon roller complete with bearings
- Easily adaptable for a variety of uses, low profile
- Ideal for cable or ladder tray work
- Remove legs to convert to "Flat Trench Rollers"

Part No.	Roller Material	Max cable Dia. (mm)	Dimensions (mm)	Wt (kg)
SPP-3A-140L	Nylon	150	600 (L) x 260 (W) x 150 (H)	3.8
SPP-3A-140AL	Aluminium	150	600 (L) x 260 (W) x 150 (H)	4.7

### 4-Way Cable Tray Roller - SPP

**Part No. SPP-TR-605R**

- 5 bar rollers with sealed bearings
- Mounting bracket suits cable ladder and cable tray (1mm to 50mm)
- Large wind in dials for easy opening and closing
- Zinc plated



Part No.	Max cable Dia (mm)	Dimensions (mm)	WLL (kg)	Wt (kg)
SPP-TR-605R	80	125 (L) x 260 (W) x 360 (H)	200	4.45

### 90° Cable Tray Trapping Roller - iTOOLco

iTOOLco's 90° Trapping Tray Rollers install in three easy steps and are compatible with most trays. Navigating difficult corners is a snap with 90° Trapping Tray Rollers.

Two Trapping Tray Rollers of the same size combine to encase conductors and handle elevation changes. Opens and closes from either side providing the utmost job-site flexibility.

Part No.	Description	Dimensions (mm)	Weight (kg)
TR9005	127mm - 90° Tray Roller	241L x 140W x 254H	4
TR9010	245mm - 90° Tray Roller	356L x 140W x 254H	6.4

Replacement Underpins - SP-181

### Cable Tray Roller - iTOOLco

iTOOLco's 127mm Cable Tray Rollers install in three easy steps and are compatible with most trays. Secures in place with two locking underpins.

- Withstands cable pulling loads of up to 909kg\*
- Each roller rides on rated bearings
- Steel welded frame
- Handle a variety tray types
- Can install above or below the tray

Part No.	Description	Dimensions (mm)	Weight (kg)
TRST05	127mm Roller, ½ inch Bolt with 2 Locking Underpins	165(L) x 51(W) x 216(H)	1.8
TRST10	254mm Roller, ½ inch Bolt with 2 Locking Underpins	317.5(L) x 51(W) x 216(H)	3.9

Replacement Underpins - SP-181





### Cable Tray Threaded Rod Mount - iTOOLco

Mount two brackets above or below your tray on the threaded rod, install the framing member, and attach the tray roller. (Sold in pairs)

- 3/8" and 1/2" or 5/8" and 3/4" sizing with all thread slots for easy setup
- Mounting clamp ensures safe & secure feeding
- Clamping bolt keeps bridge secure
- Mounting pocket allows for a quick and simple connection



Part No.	Description	Dimensions (mm)	Weight (g)
TRM500	Suits 3/8 & 1/2" Threaded Rod	100 (H) x 89 (W) x 76 (L)	910
TRM750	Suits 5/8 & 3/4" Threaded Rod		



### 4-Way Cable Tray Roller - Current Tools

Current Tools 4-Way trapping roller mounts quickly and easily to the cable tray with the quick release ratchet strap. 100mm opening and flip-top head allows for easy access for cable setting.

- Quickly and easily mounts to cable tray with included ratchet strap
- Securely attaches to most styles of cable tray from 300 to 900mm wide
- Roller assembly has 100mm opening and can be quickly repositioned
- Designed for multi-directional pulling
- Provides low friction wire pulling to ease the load on cable puller
- No loose parts
- Made in the USA

Part No.	WLL (kg)	Suits Tray (mm)	Wt (kg)
9544CR	90	300 to 900	9.1

### Straight Cable Tray Roller - Current Tools

Current Tools straight cable tray rollers mount quickly and easily to the cable tray with the 2 supplied J-hooks.

- Installs through bottom of tray for easy removal after installation
- Individual rollers keep rolling with each cable even after several cables have been installed
- Welded steel frames
- Length adjustment slots
- Long life steel ball bearing rollers
- Each roller supplied with 2 each J-hooks and hardware
- Made in the USA

Part No.	Opening (mm)	Suits Tray (mm)	Wt (kg)
9518SR	160	300 to 450	3.4
9524SR	315	510 to 610	4.1

Other sizes available upon request

### Radius Cable Tray Roller - Current Tools

Current Tools radius cable tray rollers are ideal for tray corners and junctions. They mount quickly and easily to the cable tray with the 2 supplied J-hooks.

- Multiple Individual rollers keep rolling with each cable even after several cables have been installed
- Welded steel frames
- Long life steel ball bearing rollers
- Length adjustment slots for different tray widths
- Each roller supplied with 2 J-hooks and hardware
- Made in the USA

Part No.	Opening (mm)	Suits Tray (mm)	Wt (kg)
9518RR	138	300 to 450	4.6
9524RR	138	510 to 610	4.8

Other sizes available upon request



**MADE IN THE USA**



## Sheaves and Guides - Hook Style

### Hook Type Sheaves - Current Tools

#### Part No. Various

- 1814kg (2000lb) capacity
- Forged steel hooks with 25mm opening
- Welded steel frames
- 127mm wide aluminium sheaves with self-lubricating bearings
- EZ\* opening - Scan or Click QR-Code

Part No.	Diameter (mm)	Width (mm)	Wt (kg)
406	152	127	5.2
412EZ*	305		8.4
418EZ*	457		12.7
424EZ*	610		17.2

#### Part No. 812/818/824/836

- 3628kg (4000lb) capacity
- Forged steel hooks with 35mm opening
- Heavy duty welded steel frames
- Self-lubricating bearings

Part No.	Diameter (mm)	Width (mm)	Wt (kg)
812	305	127	10.9
818	457	152	20.9
824	610	165	31.4
836	914	171	45.9

**EZ Opening for easy cable installation & removal. See QR-Code below**



### Right Angle Twin Yoke Sheave - Current Tools

#### Part No. 4424

- 1814kg capacity
- Forged steel hooks with 25mm opening
- Yokes rotate independently for various setups
- Welded steel yoke frames
- 127mm wide aluminium sheave with self-lubricating bearings
- Weight 22.7kg



### Triangle Sheave Cable Guide- Current Tools

#### Part No. 333

- 2950kg capacity
- Adjustable center sheave to vary pulling radius from 495mm - 915mm
- Pinned steel yoke for easy removal
- Aluminum frame for light weight
- Weight 11.8kg
- EZ\* opening - See QR-Code



### Radius Twin Yoke Sheaves - Current Tools

#### Part No. Various

- 1814kg capacity
- Heavy duty design with aluminium sheaves and frame for light weight
- Sheaves spaced to prevent cable damage
- Aluminum sheaves 127mm wide with self-lubricating bearings
- EZ\* opening - See QR-Code

Scan or Click to View EZ\* opening video

Part No.	Sheave Radius (mm)	Number of Sheaves	Wt (kg)
9224	610	6	30
9236	915	9	39
9248	1220	12	47



### Duct / Conduit Rodders

#### Traceable Duct Rodder - 4.5, 6, 9 & 11 mm - SPP

##### Part No. SPP-DR-Series

Utilised to prepare for cable installations in Electrical & Telecommunication conduits ranging from 20 to 200mm OD. The tough flexible rod is ideal for pushing or pulling draw ropes and small cables through conduits / ducts.



11 mm Rod & Reel



9 mm Rod & Reel



6 mm Rod & Reel



4.5 mm Rod & Reel

#### Features

- Quality Fibreglass rod coated with abrasion resistant UV stable polymer
- All sizes supplied standard with an internal copper wire for traceability.
- Supplied with Stainless Steel End Fitting & Removable Pulling Eyes for 6, 9 & 11 mm
- Brass End Fitting & Removable Pulling Eyes for 4.5 mm
- 9 & 11 mm Reels are Powder-coated and fitted with a Drag Brake and Wheels
- 4.5 & 6 mm Reels are Galvanised
- All Rodders include a Jointing/Repair Kit in pouch attached to the Reel (details below)
- Full range of Accessories available (detail below)

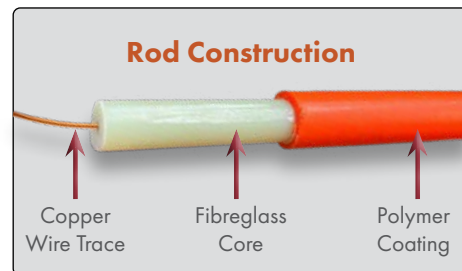

#### Rod Construction

Copper Wire Trace, Fibreglass Core, Polymer Coating

#### Jointing Kit Components (Included with Rodder)



#### Ordering Information

Rodder Part No.	Rod OD (mm)	Rod Length (m)	Jointing Kit Part No.	Jointing Kit Components
SPP-DR4.5-60	4.5	60	SPP-JK4.5	1 x Joiner 1 x Rod End 1 x Pulling Eye 2 x Allen Keys - 6, 9, 11 mm Rod 1 x Glue 1 x Rubber Rod Grip
SPP-DR6-60	6	60	SPP-JK6	
SPP-DR6-100	6	100	SPP-JK6	
SPP-DR9-100	9	100	SPP-JK9	
SPP-DR9-200	9	200	SPP-JK9	
SPP-DR11-200	11	200	SPP-JK11	
SPP-DR11-300	11	300	SPP-JK11	

\*Nominate Length of rod required - Supplied with Rod Ends



#### Accessory & Jointing Kit Pouch (Included with Rodder)

#### Accessories

Part No.	Rod Grip	Rod End	Pulling Eye	Swivel Rod End	Rod Joiner	Flexible Guide	Roller Guide
	SPP-RG	SPP-RE-*	SPP-PE-*	SPP-SRE-*	SPP-RJ-*	SPP-FG-*	SPP-RG-*
Image							

\*Nominate Rod Size

Other Accessories Available, Contact TEN for further information

## Conduit Cleaning - Wire Brushes and Squeegees

### Wire Brushes - SPP

#### Part No. Various

- Clean debris from the inside of conduits or ducts (50 to 200mm) before cable hauling/pulling
- Welded eyes for rope attachment
- Galvanised

Part No.	Description	Approx Equipment OD (mm)	Suit Conduit Size (mm)
SPP-WB-050	Wire Brush	55	50 Electrical
SPP-WB-063		70	63 Electrical
SPP-WB-080		90	80
SPP-WB-100		110	100
SPP-WB-125		130	125
SPP-WB-150		160	150
SPP-WB-200		230	200



Contact TEN for Telecommunications Duct Cleaning Needs

### Rubber Conduit Cleaner - SPP

#### Part No. Various

- Cleans finer dirt and debris from conduits or ducts (50 to 200mm). For larger or stubborn debris, use wire brush (SPP-WB) first
- Welded eyes for rope attachment.
- Galvanised finish with 5 rubber squeegees

Part No.	Description	Approx Equipment OD (mm)	Suit Conduit Size (mm)	Wt (kg)
SPP-RCC-050E	Rubber Conduit Cleaner	46	50 Electrical	0.35
SPP-RCC-063E		58	63 Electrical	0.40
SPP-RCC-080		85	80	0.95
SPP-RCC-100		105	100	1.50
SPP-RCC-125		130	125	2.35
SPP-RCC-150		155	150	2.90
SPP-RCC-200		205	200	5.05



### Rubber Lubricant Spreader - SPP

#### Part No. Various

- Used to spread Lubricant through conduits or ducts (50 to 200mm)
- Galvanised finish with rubber squeegees

Part No.	Description	Approx Equipment OD (mm)	Suit Conduit Size (mm)	Wt (kg)
SPP-RLS-050E	Rubber Lubricant Spreader	46	50 Electrical	0.15
SPP-RLS-063E		58	63 Electrical	0.20
SPP-RLS-080		85	80	0.45
SPP-RLS-100		105	100	0.60
SPP-RLS-125		130	125	0.75
SPP-RLS-150		155	150	0.95
SPP-RLS-200		205	200	1.30



See pages B28 & B29 for the range of Polywater Lubricants



### Conduit Proving Mandrels

#### DUCT Proving Mandrels - SPP

##### Part No. SPP-PM-Series

Used for testing circular integrity of Conduits before cable Hauling

##### Features

- Manufactured standard with Stainless-Steel Wire Rope and Thimbles or Stainless-Steel Eye Nuts & Threaded Rod attachments to secure ropes for cable hauling
- Ideal for testing NBN & Telstra ducts or conduits
- Tests electrical and communications conduits
- Made from high quality HDPE material for long life and lubricity



50mm Proving Mandrel  
SPP-PM-50E



80mm Proving Mandrel  
SPP-PM-080



Stainless Steel Eye Nut & Threaded Rod



Stainless Steel Wire Rope, Thimble & Ferrule

Supplied with Stainless Steel Fittings

**STAINLESS STEEL eye fittings means extended service life**

Part No.	Conduit Size (mm)	Conduit Type	Mandrel Length (mm)	Mandrel OD (mm)	Overall Length (mm)	Wt (kg)	Eye Fitting (mm)
SPP-PM-18		Telco	40	18	115	0.05	2 <sup>1</sup>
SPP-PM-24		Telco	40	24	115	0.05	2 <sup>1</sup>
SPP-PM-28		Telco	60	28	160	0.05	3.2 <sup>1</sup>
SPP-PM-32		Telco	60	32	180	0.05	3.2 <sup>1</sup>
SPP-PM-38		Telco	60	38	180	0.07	3.2 <sup>1</sup>
SPP-PM-50T	50	Telco	80	47	145	0.15	6*
SPP-PM-63T	63	Telco	100	60	180	0.30	8*
SPP-PM-50E	50	Electrical	80	40	200	0.10	3.2 <sup>1</sup>
SPP-PM-63E	63	Electrical	100	52	180	0.25	8*
SPP-PM-080	80	Electrical	180	74	260	0.75	8*
SPP-PM-100	100	Electrical	180	90	275	1.10	10*
SPP-PM-125	125	Electrical	245	113	340	2.20	10*
SPP-PM-150	150	Electrical	245	130	340	2.85	10*
SPP-PM-200	200	Electrical	280	184	375	5.80	10*

1 = Stainless Steel Wire & Thimble - \* = Stainless Steel Eye-Nut

## Conduit Blowing

### Electric Blower Kit

#### Part No. EBK2-1300

This high volume, low pressure blowing system is used to blow a balloon type bag attached to a draw line or string down a conduit. The draw line is then used to pull a heavier hauling rope back to your start position. This system can easily rope a 100mm conduit 300-500 metres. Dual stage motors, 230VAC/50Hz Electric Power Blower. 1300W delivering approximately 3.5 cubic metres of air per minute.

Kit includes:

- 1 x Blower EBK2-1300
- 5m x 50mm hose EBP-5M50
- 1 x Hand-Gun EBH-30
- 1 each Conduit Seal off



Part No.	Description
EBK2-130K	Complete blowing kit
EBK2-1300	Blower unit only (11.9kg)
ECS-12	Conduit seal off for 12-40mm
ECS-50	Conduit seal off for 40-70mm
ECS-110	Conduit seal off for 70-160mm
EG-3, EG-5, EG-7	Rope grommets 3/5/7mm



## Condux Power Dart Blower

#### Part No. 08030004

The Condux Power Dart Blower is a pneumatic rodding system especially suited for long duct runs.

A three-motor system allows you to choose the correct pressure output for your needs. With all three motors engaged, the Power Dart Blower will deliver a market leading 300cfm (8.5m<sup>3</sup>/min) of air at 3psi maximum pressure.



- Compressed air system for long duct runs in up to 152mm diameter conduit
- Blow 13mm line or measuring tape over 610m
- Three-motor system allows choice of speed
- Can deliver up to 300cfm/8.5m<sup>3</sup>/min of air at 3psi/0.2bar maximum pressure
- Main unit weighs only 14kg
- Operates at 220V



**3 Motor System  
for complete control  
and maximum distance**



### Line Carriers - Rubber

**Part No. Various**

Flexible rubber duct projectile cones are durable for many repeated uses. These projectiles are fast & efficient for long runs with easy pull back.



### Line Carriers - Plastic

Fast and efficient plastic missile line carriers for conduit fishing with high speed blowers even in/out of round duct.



### Foam Carriers

**Part No. Various**

Lightweight foam conduit line carrier easily blows through duct. Best suited for short runs and runs with multiple bends.



### Chute Carriers

**Part No. Various**

Tie a line or webbing to a chute, insert the chute into the conduit or duct, and blow compressed air propelling the chute to the end of the duct.



### Accessory Bag

A convenient canvas bag holds the power dart hose, and an additional inner bag holds the Line Carriers, Foam Carriers, Seal-off Body and Seal-offs.

### Poly Blowing Line

**Part No. Various**

Blow through conduit attached to darts

Duct Projectile Options	
Part No.	Size (mm)
08031820	51
08031830	76
08031840	102
08031850	127
08031860	152
08031880	203

Line Carrier Options	
Part No.	Size (mm)
08067900	51
08030100	76
08030300	102
08030400	127
08030500	152

Foam Carrier Options	
Part No.	Size (mm)
08032200	25
08033600	30
08039800	38
08032400	51
08032500	76
08032100	90
08032600	102
08059100	127
08059200	152

Chute Carrier Options	
Part No.	Chute (mm)
08033532	51 Nylon
08033548	76 Nylon
08033564	102 Nylon
08033580	127 Nylon
08033596	152 Nylon

Part No.	Description
08030060	Power dart blower accessory bag

Part No.	Description
08561285	Poly Line Pail 1981m, 890N BL
08561297	Poly Line Pail 762m, 2002N BL
08073900	Poly Tape 914m, 578N BL

## Cable Installation & Handling Equipment

### Drum Jack Stands - Scissor - SPP

Part No. SPP-DJ-Series

2T Jack shown  
Part No. SPP-DJ-2T

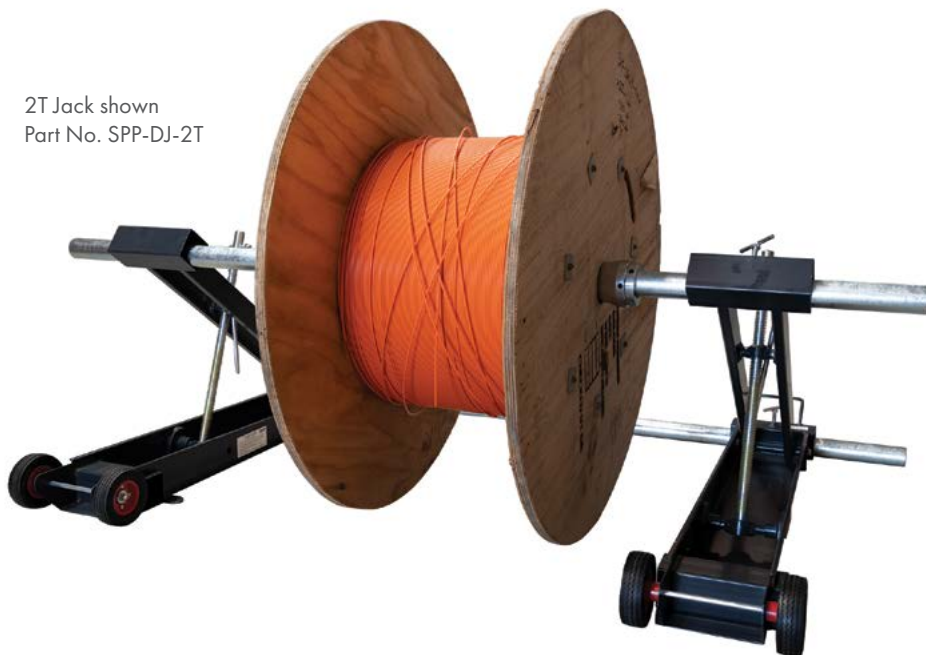

#### Features

- Collapsible design for easy transport and storage
- Bolt-down points for secure and permanent fixing
- Can be set-up on uneven ground, as drum can be leveled with by adjusting one side
- Nylon wheels and handle for easy maneuverability
- Significant reduced pinch points
- Reinforced retaining cup and sealed bearing for threaded spindle
- Jacks labeled with ratings
- Easy wind up design with handle or hex head for fast winding with rattle gun
- Powder-coated finish
- Supplied with two spindles
  1. Jack joining spindle for rigidity during operation
  2. Drum spindle and placement collars to hold drum during operation



Wheels and handle for easy maneuverability

Bolt-down points for secure and permanent fixing



Easy wind design with handle and hex head for a faster winding action with rattle gun



Jack shown folded for storage & transport

#### Ordering Information

Part No.	Spindle OD & Wall thickness (mm)	Min/Max Drum Diameter (mm)	Max Drum Width (mm)	WLL (kg)	Suitable for	Wt per Set (kg)
SPP-DJ-2T	60 / 5	1800	1180	2000	1 to 2T Drums	90
SPP-DJ-4T	70 / 8	1400/2400	1180	4000	2 to 4T Drums	180

### Real Jacks™ Drum Stand - iTOOLco

#### Part No. RJ6K

iTOOLco's Real Jacks™ make cable pulls run smooth and easy. These innovative drum jack stands have four sealed bearings that capture the axle to prevent the drum from traveling during the pull.

#### Features

- Closed head traps axle preventing it from falling out or traveling horizontally
- Separate sides allow the jacks to be used safely on uneven ground
- Easily folded for storage and transportation
- Can be used with 560 to 1675mm drums
- Easy to carry at 16kg per side
- For use with iTOOLco Axles - see below "Axle Specs" for details
- Set up in less than 1 minute
- Four bearings make wire pulling smooth and easy
- No drills or extra tools required



Supplied as a set of 2

Capacity  
**RJ6K-AX02**  
 2.7 Tonne  
**RJ6K**  
 1.3 Tonne

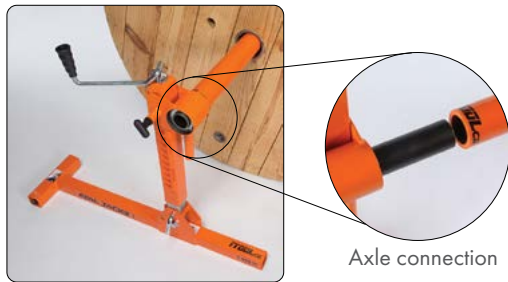

Axle connection



CLICK or SCAN  
 for Real Jack  
 Stand Video



Separate Stands and height adjustment allows for use on uneven ground

### Real Jacks™ Stand Specifications

Part No.	Description	Spindle	WLL (kg)	Min/Max Drum Diameter (mm)	Dimensions per side (mm)	Wt per Set (kg)
RJ6K-AX02*	Real Jack Drum Stand	AX02	2700	560 to 1675	940L x 254W 290H (Folded) 978H (Assembled)	32 (Without Axle)
RJ6K		AX08	1300			

\*RJ6K-AX02 Includes axles AX02 & AX08

### Jack Rack™ For Real Jacks - iTOOLco

#### Part No. JR01

Transport multiple sets of Real Jacks jack stands & Real Axles easily.

- Transport 5 Sets of Jacks and Axles at Once
- Fits Through 30 inch Doorways
- Made From Sturdy US Steel
- Convenient Fixed Handle for Hand Trucking About The Job Site
- Heavy Duty Caster with Brakes



Part No.	Length (mm)	Height (mm)	Width (mm)	Weight (kg)	Capacity
JR01	1041	1143	711	38.5	Up to 5 sets of Real Jacks™

**iTOOLco.**



### Real Tender™ Rope Tender - iTOOLco

**Part No. RT01**

The iTOOLco Real Tender is a smarter rope tender. Light and maneuverable, it's easy for one person to set up and transport. It can also be used horizontally or vertically making it flexible on the job.

- Saves time
- Crank handle for faster re-spooling
- Prevents injuries from lifting and handling rope
- No more lifting heavy wire spools
- Axle-less technology
- Multi-directional
- Rolls over rough terrain on job site
- Keeps expensive rope high & dry
- Stores 1 x set of Real Jack Drum Stands

Part No.	Length (mm)	Width (mm)	Weight (kg)	Spool Widths (mm)	Spool Dia.	Weight limit (kg)
RT01	1243-1524	584	173	304-889	304-813	136



### Real Spool™ - iTOOLco

**Part No. RS01**

The iTOOLco Real Spool is an innovative lightweight steel spool for pulling ropes.

- Holds up to 300 Lbs
- Made from US14 gauge steel
- Stronger than wood spools
- Won't splinter and fall apart
- Works great with iTOOLco Real Tender™
- Stores 1 x set of Real Jack Drum Stands

Part No.	Length (mm)	Height (mm)	Width (mm)	Weight limit (kg)
RS01	724	610	610	136

\*Rope not included \*See page B27 for available Rope



### Real Pallet Jack™ - iTOOLco

**Part No. RPJ10K**

Deliver and place reels to your final installation point safely and effortlessly. iTOOLco's Real Pallet Jack are a portable, heavy-duty solution for transporting spools up to 4,545kg (10,000 lb).

Made with all welded steel construction, loading and unloading the Real Pallet Jack is easy. Loading from the drum side minimizes the potential of wire damage from forks. The dual sided gates enable you to

load spools from either side of the jack. Whatever their size, spools automatically center the arbor hole with the spindle—ensuring the spool is perfectly positioned for a quick, smooth payout every time. Maneuverability on the job-site is a snap using a forklift.

- Folded up height of 457mm

**Added Bonus:** Real Pallet Jacks collapse and stack for easy compact storage.



**4.5T Capacity**

RPJ10K shown with side gates open for Drum placement



CLICK or SCAN for Real Pallet Jack Video

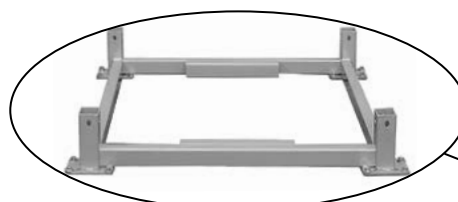

Transport Frame Sold Separately



RPJ10K shown with Transport Frame & Castor Set Sold Separately

Part No.	Includes	Max Drum size (mm)	Stored Dimensions (mm)	Jack Extended (mm)	Weight (kg)
RPJ10K	Pallet Jack, Axles & Arbors	990 W x 2150 H	457 H x 1219 W x 1219 D	1410 x 1219 x 1219	127
RPJF01	Pallet Jack Transport Frame	-	330 H x 1295 W x 1270 D	-	59
BCP04	Castor Pack - Heavy Duty	-	485 H x 330 W x 330 D	-	33



### Real Big Jack™ - iTOOLco

Part No. RBJ20K

iTOOLco's Real Big Jacks™ are an innovative jack stand for transporting and feeding heavy spools of wire. Real Big Jacks™ feature fork lift slots for easy lifting and movement about the site and can accommodate spools up to 3.05m (10') diameter x 1.83m (6') wide (standard unit), and weighing 9090kg (20,000lb). with a uniquely patented design that allows these heavy spools to spin easily, a power feeding unit is typically not needed.

With the addition of the Real Big Jacks™ Expansion & Axle Kit, Real Big Jacks™ will accept spools up to 2.24m (88") wide & 3.05m (10') Tall.

- Forklift from all 4 sides
- Pull Cable from almost anywhere including a trailer
- Axle rides on 4 rated bearings

**9.0T Max Capacity**



RBJ20K shown with axle set-up



RBJ20K pockets for forklift tynes



RBJ20K jack lifting point

Part No.	Description	Includes	Dimensions (mm)	Drum Dimensions (mm)/ Capacity (kg)	Weight (kg)
RBJ20K	Real Big Jacks	Pallet Jack & 2 x Axle Collars	1473L x 1676W x 1753H on wheels x 1676H off wheels	On Wheels - 2134H x 1524W / 4545 Off Wheels - 3048H x 1524W / 9090	255
AX04	Real Big Jacks Axle (Sold Separately)	Axle (Uncoated)	2133L x 76.2D	1829W / 4545	57
RBJA01	Real Big Jack Expansion & axle Kit (Sold Separately as Kit)	1 x Inner telescopic tube 1 x Solid Axle 2 x Axle Collars	-1830 to 2286L - 3048L x 76.2D - NA	Max 2235W / 9090	NA

### Real Axles™ - iTOOLco

Part No. AX-Series

iTOOLco's Real Axles are the industry's best axles for wire pulling jobs. With high chromium content, Real Axles are durable and work perfectly with the Real and Roll Jacks.



Part No.	Description/Suits	OD x Length (mm)	Weight (kg)	Capacity (kg)	Max Reel Width (mm)
AXS01	Solid - Powder Coated / RJ6K	30 x 1829	16.3	1360	1448
AX02	Tube - Powder Coated / RJ6K	70 x 1829	20.4	2721	1448
AX03	Tube - Powder Coated / RJ6K	70 x 1524	20.4	2721	1143
AX04	Tube - Galvanised / RJ6K / RBJ20K	76 x 2133	57.6	4545	1829
AX08	Tube - Galvanised / RJ6K	60 x 1015	6.0	1360	560

Custom length Axles available. Contact TEN for further information.

**iTOOLco's All Jack™ Lifts and Hold your workpiece in place to free up your hands, increasing productivity**



One handed gas shock holds work piece in place



Perfect for overhead work support conduits and cable tray



## Material Handling Equipment

### iToolco All Jack™ - iTOOLco

Part No. AJ01

#### Features

Increase productivity and decrease fatigue using iTOOLco's All Jack™. Install conduits & pipe, cable tray, lights, switchboard cabinets and panels, gyprock and much more with this innovative jack designed to lift and support the weight of your workpiece while you anchor it into position. High ceilings and ladder work are not a problem for this dynamic tool. Reach from 1.47m to a staggering height of 4.15m.

The industrial gas shock ensures a snug, stable support that stays in place while you complete the installation. Once your workpiece is secured into place, simply remove the All Jack™ by releasing the shock. More powerful than a typical support pole, the All Jack's gas shock can handle your most challenging jobs.

**VERSATILE HEAD WITH BUILT IN SCREW JACK**  
Pre-drilled holes for field customization & a built in V-groove to capture conduit or pipe

**GAS SHOCK LEVER**  
For quick one handed lifting operation up to 9kg

**CLICK or SCAN for All Jack Instruction Video**

**LOCKING PINS**  
When locked All Jack™ can be used as a screw jack to support 79kg

**120MM EXTENSION**  
Stores on cart

**EXTENSION HOLDER**  
is also a universal bracket for mounting to ladders or lifts

**Includes Support Rods, Extra Holding Bands & Carry Bag**

**FAST ADJUSTMENT**  
to meet your angle requirement

**SUPPORT RODS**  
for Dome Fixtures

**ANIT-SLIP PADDING**  
with anchoring holes in base

#### All Jacks™ & Accessory Ordering Information

Part No.	Description	Capacity (kg)	Height (mm)	Weight (kg)
AJ01	Workpiece support	Quick Lift 9 Locked as screw jack 79	Collapsed - 1.47 Extended - 4.15	11.34
AJA01	Drywall support		310L x 107W	0.91
AJA02	Pipe & Stud Holder		203L x 42W	0.61
AJA03	Adjustable Fence Support		407L x	1.6
AJAK01	All Jack Accessory Kit (AJA01-02-03)			3.12



### Cable Drum Handling Equipment

#### A Frame Cable Drum Stands



- Various sizes, styles available
- 1.5 Tonne up to 30 Tonne
- Power pack and braking options
- Contact TEN with your requirements



#### Reel Roller - Current Tools

##### Part No. 610



Sold individually  
Two required

- Easy set-up for ground level cable reel payout
- Integral ramp for reel loading
- Roller lock for reel removal
- 5-position roll adjustment for various reel diameters
- Heavy duty permanently lubricated ball bearing rollers
- Made in the USA

Part No.	Dimensions (mm)	Max Drum Dia. (mm)	Max Drum Width (mm)	Max Drum Wt (kg)	Reel Roller Wt (kg)
610	267 x 642	-	1065	900per pr	18.2 ea



#### Reel Roller - Current Tools

##### Part No. 613

- Easy set-up for ground level cable reel payout
- Integral ramp for reel loading
- Roller lock for reel removal
- 5-position roll adjustment for various reel diameters
- Heavy duty permanently lubricated ball bearing rollers
- Made in the USA

Part No.	Dimensions (mm)	Max Drum Dia. (mm)	Max Drum Width (mm)	Max Drum Wt (kg)	Reel Roller Wt (kg)
613	806 x 940	-	762	1100	34



#### Cable Reel Roller - Current Tools

##### Part No. 615

- Heavy duty all welded construction
- Handles up to 13.6 Tonne cable reels
- One roller adjusts for various reel sizes
- Speed control adjustment
- Foot control for remote operation
- Heavy duty 10 amp. motor\* for long service life
- Convenient fork sockets on sides
- Made in the USA

Part No.	Dimensions (mm)	Max Drum Dia. (mm)	Max Drum Width (mm)	Max Drum Wt (kg)	Unit Wt (kg)
615	3100 x 1550	3650	2400	13,600	1275

\* 110v motor - Transformer required

### LANCIER



EKR350



EKR700



## Cable Pusher - Lancier

### Part No. Various

- Used for underground cable pushing
- Installation forces are applied evenly across cable with caterpillar track pusher, rather than being pushed via wheel
- Suitable for narrow trenches
- Can be linked in series
- Optional multiple unit control available

### Benefits

- Providing supplementary pulling and pushing force when laying heavy cables
- Optimum and gentle transmission of power to the cable
- Suitable for narrow trenches
- No cabling winches necessary in cascade connection
- Length measuring device
- Electric switch for reversing direction of push
- Integrated Disc brake

### Field of use

The caterpillar cable-roller is used for laying delicate underground cables which are sensitive to pulling-tension and surface pressure. It may be used as a cable forward feeding roller either in association with a cabling winch, to reduce the pulling tension on the cable, as a cable-laying roller on its own or to assist in drum payout.

Several EKR's are needed at intervals along the cable track to provide an effective reduction in the pulling tension experienced by the cable. The number required will depend upon how sensitive the cable is to pulling tension and the difficulty of the track.

Part No.	EKR 350	EKR 700
Max Pulling/ Pushing (kN)	3.5	7kN
Max Speed (m/min)	10	10
Cable Ø (mm)	30 - 150	30 - 150
Engine Type	Electric	Electric
Engine Output (kW)	1.1	1.5
Operating Voltage	400 V, 3-phase, 50Hz 220 V, 50Hz (optional)	400 V, 3-phase, 50Hz
Dimensions (mm)	1100 (L) x 450 (W) x 930 (H)	1720 (L) x 550 (W) x 1100 (H)
Options	Series connection with switch board + cable remote control Cable length measuring device	
Weight (kg)	115	185

**7 & 10kN Hydraulic and 7kN Petrol versions available**  
Contact TEN for further information

### Current Tools FOR THE PROFESSIONAL ELECTRICIAN



## Electric Cable Feeder - Current Tools

- Hinged upper drive to allow for easy side loading
- Dual drive motors for maximum grip on cables
- Cable separator guides cables to ensure positive grip on tires
- Heavy duty transport caster with quick release mechanism
- Variable speed control
- Operate with remote pendant or optional foot switch
- Self-lubricating drive chains

Part No.	Model 99
Cable Capacity (mm)	6.3 to 88.9
Total width of all cables (mm)	152.4
Maximum Pushing Force (kg)	Single cable: 113 All cables: 452
Feeding speed (m/ min)	0.0 to 11
Wt (kg)	156.5

Requires 110v Transformer

## Rope - Overhead and Underground

### Telstra - Parramatta Hauling Rope

Part No. Various



- Polypropylene rope, Telstra approved / certified
- 6mm in diameter with 2 Blue and 1 Yellow strand
- Tangle free uncoiling to coil end, no waste



Part No.	OD (mm)	Length (m)	Colour	Break Force (kN)
ROS0614	6	400	Blue/ Yellow	602
ROS0652	6	500		

ROS0652 48 Roll MOQ

### High Strength Pulling Rope - ROBUS

Part No. Various



More sizes available Contact TEN

ROBUS rope is an ultra-high strength rope developed to meet the need for light but ultra strong ropes.

ROBUS ropes are made from quality HMPE fibre.

- High performance 12 strand braided HMPE rope
- Can be used everywhere where optimal strength vs diameter is required and temperature is normally below 40°C

#### Characteristics

- Extremely high strength
- Light weight
- Abrasion resistant
- Low stretch
- Neutral buoyancy
- Splicable
- Flexible

#### Applications

- Alternate to wire rope
- Winch lines
- Tow lines
- Rigging lines
- Utility line

Polyester Cover available on request

Part No.	OD (mm)	Wt per metre (Per 100m/kg)	Max Break Force (T)
H-54-006*	006	2.3	4.2
H-54-008*	008	3.9	7.0
H-54-0010*	010	7.2	13.1
H-54-0012*	012	9.0	16.3
H-54-0014*	014	10.3	19.5
H-54-0016*	016	13.8	26.0

\*Specify Length in metres

### Double Braided Hauling Rope - Hampidjan

Part No. DBPR-Series



- Manufactured in Australia with a braided polyester cover over a braided Polyester core
- Ideal for use as winch and tow lines and for pulling cable

#### Characteristics

- High strength
- High UV resistance
- Flexible & Splicable

#### Applications

- Winch, Tow & Rigging lines
- Pulling and stringing line

Lifting Rope with Clevis eyes available - Contact TEN

Part No.	OD (mm)	Wt per 100 m (kg)	Max Break Force (T)
DBPR-12*	12	11.10	3.49
DBPR-14*	14	13.90	4.36
DBPR-16*	16	18.25	5.75
DBPR-18*	18	22.20	6.98
DBPR-20*	20	27.30	8.59
DBPR-22*	22	33.30	10.48
DBPR-24*	24	41.60	13.10
DBPR-26*	26	46.30	14.56

\*Specify length in metres

### 3 Strand Polypropylene Rope - Hampidjan

Part No. Various



- Higher breaking strength
- Abrasion resistance
- Excellent shock absorption
- Better grip
- Minimal elongation
- Durable and ultraviolet stabilized
- Excellent shape retention
- Strength: wet/dry 100%
- Floats/sinks: Floats
- Elongation: Moderate
- Water absorption: None
- Chemical Resistance
  - Acids: Excellent
  - Alkalis: Excellent
  - Oil/Gas: Very Good

Part No.	OD (mm)	Wt per 100 m (kg) 250m Standard (Coil)	Max Break Force (T)
PPR-12*	12	7.0	2.84
PPR-14*	14	9.0	3.91
PPR-16*	16	12.0	4.90
PPR-18*	18	15.0	5.50
PPR-20*	20	18.0	7.52
PPR-22*	22	22.0	8.45
PPR-24*	24	26.0	10.20
PPR-26*	26	31.0	11.87

\*Specify Length in metres

**Polywater**  
Solutions at work.

## Specific Lubricants Available

- **Fibre Optic**
- **Low-Smoke Zero Halogen**
- **High Water Environments**
- **Cable Blowing**
- **Winter Conditions**

## FULL RANGE OF CABLE LUBRICANTS TO SUIT ALL APPLICATIONS

**Polywater**  
Solutions at work.

### Cable Pulling Lubricant

#### J Lubricant - Polywater

##### Part No. Various

Polywater Lubricant J is a high performance, clean, slow-drying, water-based gel lubricant. Lubricant J provides maximum tension reduction in all types of cable pulling. It is especially recommended for long pulls, multiple-bend pulls and pulls in a hot environment. Lubricant J dries to form a thin lubricating film which retains its lubricity for months after use.

Polywater Lubricant J is a specification-grade lubricant that does not promote flame propagation when used with fire-retardant cables and systems. It is harmless to humans, environmentally safe, compatible with common Australian cable jacket materials, and can be easily applied as part of the unique Polywater® Lubricant Application System.

##### Features

- High performance cable lubricant for heavy cable installations
- Maximum Friction Reduction
- High Cling Factor
- Compatible with common Australian cables
- Temperature Stable
- Non-Combustible Residue
- Specification Grade "J" - The lubricant contain no waxes, greases, silicones, or polyalkylene glycol oils
- Application System available in 'Front End Packs'
- Complete cleanup is possible with water

#### J Front End Pack™ Lubricant - Polywater

##### Part No. J-99 & J-110

The front end pack is a conduit-sized polyethylene bag of lubricant. The Front End Pack™ travels through the conduit on the winch line prelubricating the conduit ahead of the cable being pulled.



Part No.	Description
J-128	3.8L Bucket
J-640	19L Drum
J-DRUM	208L Drum
J-99	950ml Front End Pack Suits 40mm - 75mm Conduits
J-110	1.9L Front End Pack Suits 75mm+ Conduits



CLICK or SCAN for  
Polywater J Application  
Video

SCAN OR CLICK TO VIEW VIDEO

#### Polywater® Front End Packs lubricate ahead of the cable during the pull





Bulk 208 litre Drum  
PR-DRUM



19litre Drum  
PR-640

## PR Lubricant - Polywater

### Part No. Various

Polywater® PR Power Cable Lubricant is a complex polymer liquid lubricant that provides excellent friction reduction.

Perfect for installing cables from the transformer to the service entrance of businesses or homes.

Polywater PR is a stringy, silicone-enhanced liquid that can be poured or pumped into duct.

Pourable 3.8litre Bottle  
PR-128



**Universal, Pourable  
Underground Cable Pulling  
Lubricant**

### Features

- Field Friendly: Packaging designed for the installer
- High Shear Resistance: Allows friction reduction even under high sidewall pressure in bends
- Slow Drying: The residue is a thin, slippery film that retains lubricity for months after use
- Compatible with Common Cables: Suitable for use on many cable jackets

Part No.	Description
PR-128	3.8 litre bottle
PR-640	19 litre drum
PR-DRUM	208 litre drum



Bulk 208 litre Drum  
LZ-DRUM



## LZ Lubricant - Polywater

### Part No. Various

Polywater® LZ offers proven cable compatibility, superior combustion resistance, and an inherently low coefficient of friction.

Polywater LZ should be specified for installations of LSZH/LSHF cable in ducts and where fire propagation is a concern.

**Suitable for use on  
CPE and CSPE Fire-Retardant  
Cable Jacket**

### Features

- Low Friction Coefficient: Maximum tension reduction on all types of cable jackets
- Universal: Suitable for all types of jackets and cable
- Specification Grade: Meets the performance requirements of power and petrochemical plants, mass transit systems, airports, and high-occupancy buildings
- Compatible: Tested on LSZH/LSHF thermoplastic and thermo-set jackets
- Safe: Suitable for use on CSPE and CPE fire-retardant cable jackets



See page 31 for LP-D5 Lubricant Pump

Part No.	Description
LZ-640	19L Drum
LZ-DRUM	208L Drum

**Tested on Low Smoke - Zero  
Halogen Thermoplastic &  
Thermoset jackets**

**CALCULATE  
AMOUNT of  
LUBE  
REQUIRED**

Click the above to calculate  
the quantity of lube  
required for your project



## Cable Pull Planning Software - Polywater

### Pull-Planner™ 4.0

#### Design Safe and Efficient Cable Pulls with Pull-Planner™ 4.0

Pull-Planner 4.0 makes the planning of small or complex, large-scale cable pulling projects easier and more efficient.

Providing coefficient of friction (COF) guidance to reduce risks during cable pulls.

Calculates maximum pulling and sidewall tensions to reduce joints and avoid cable damage

#### Benefits

- Calculate pulling tensions and sidewall loadings during your job planning
- Provide a detailed pull plan to your client for sign off
- Understand your coefficient of friction and maximise the length of run, based on using a high quality or specification grade lubricant\*
- See the difference in varying coefficients of friction and determine the significant value created using a specification grade lubricant from Polywater
- Resource your job with the most suitable equipment
- Designers can minimise the number of pulling pits required in a cable run, saving considerable time and money
- Calculate the impact of bends, multiple cables, rollers/sheaves, pushing devices and back tension off drums and direction of pull
- Ability to provide a field based COF once the cable pull is complete



### Typical Pull-Planner™ Report

Pull-Planner™ Report

Pull Name: 1C 630mm <sup>2</sup> 132kV HDPE Cable 150mm Conduit Conduit ID: 150 millimeter(s)      Conduit Fill: 42.4% Total of 1 cable(s) of 1 different type(s) being pulled. Type #1: 1 Cable(s)      O.D. of 97.6 mm weight of 12.8 kgs/m Total cable weight: 12.8 kgs/m Weight correction factor set to: 1 Configuration: Single Cable Jam/Clearance Analysis: Jamming Not Possible	Polywater® J with Jacket: HDPE and Conduit: PVC Pull Detail Summary Total (Cumulative) Bend: 211.6 degrees Total Length Including Bends: 909 meters Conduit Fill 42.4 % Total Cable Weight: 12.8 kgs per meter Conduit Condition: Good	Recommended Quantity : 185 Liters Lubricant Notes Lubricant Best COF Value: 0.090 Un-Lubricated COF Value: 0.390 * Additional lubricant in recommended quantity based on long pull length. * Additional lubricant in recommended quantity based on total degree of bend.
---	--	---

Incoming Tension: 0 kN      Pull COF: 0.11

Seg #	Straight Section Slope (°)	Slope Direction	Straight Section Length (m)	Straight Section COF	Tension (kN)	Bend Type	Bend Direction	Bend Radius (m)	Bend Angle (°)	Bend Length (m)	Bend COF	Tension (kN)	Sidewall Pressure (kN/m)
1	--	--	100.0	0.11	1.38	Horizontal	--	6.00	11.3	1.2	0.11	1.42	0.24
2	--	--	55.0	0.11	2.17	Horizontal	--	6.00	90.0	9.4	0.11	2.61	0.43
3	--	--	212.0	0.11	5.53	Horizontal	--	6.00	33.0	3.5	0.11	5.90	0.98
4	--	--	115.0	0.11	7.49	Horizontal	--	6.00	33.0	3.5	0.11	7.98	1.33
5	--	--	80.0	0.11	9.08	Horizontal	--	6.00	33.0	3.5	0.11	9.68	1.61
6	--	--	215.0	0.11	12.65	Horizontal	--	6.00	11.3	1.2	0.11	12.93	2.15
7	--	--	110.0	0.11	14.45	None	--	--	--	--	0.11	14.45	--

The Pull-Planner™ 4.0 Software uses the cable pulling (tension estimation) equations common in technical studies and included in a number of industry standards. The friction coefficients in the software database are laboratory measurements. A number of field factors can influence the effective coefficient of friction. Engineering judgement and experience should be used in the selection of appropriate friction coefficients for use in the calculations.

**Program for Cable Pulling Tension Calculation and Conduit System Design**



\* See previous pages for Polywater's range of Cable Lubricants

SCAN or CLICK to view Polywater's Cable Jacket Coefficient of Friction Test methods



Contact TEN for further information on how the Planner can help your cable pull work better.

### Lubricant Pump / Applicator

#### Lubricant Pump - Polywater

**Part No. LP-D5**

Makes Cable Lubricating Clean and Efficient.

A clean and efficient way to pump all types of cable pulling lubricant from 19 to 208L drums. Polywater® LP-D5 Lubricant Pump is a drill-operated, self-priming gear pump. It pumps all varieties of Polywater lubricants directly into conduit or onto cable at optimal rates for different conduit sizes and pulling speeds.

#### Features & Benefits

- **CLEAN**  
Eliminates hand scooping, hand pouring and lengthy clean-ups
- **EFFICIENT**  
Provides labor savings with consistent lubricant and less effort when pulling cable
- **VERSATILE**  
Lubricants can be pumped into vertical or horizontal conduits
- **ADJUSTABLE**  
Works with a 12mm variable-speed drill (not included) to pump at appropriate rate based on cable size and pulling speed
- **CORROSION RESISTANT**  
Solid brass body with stainless steel shaft, which is not affected by water-based lubricants



Part No.	Description	Includes	Pump Rate	Weight (kg)
LP-D5	Drill Powered Lube Pump	1 x Lube Pump 1 x 4.7m discharge hose 1 x Extension tube for 208L drums 2 x lubricant applicators	6L per min.	3

### Conduit / Duct Adhesive

#### BonDuit - Polywater

Creates Strong, Watertight and Airtight Bonds with HDPE and Fiberglass Conduit

Polywater® BonDuit® joins polyethylene duct (PE pipe) to PVC, fiberglass, or metal conduits. It is a superior, easy-to-apply alternative to joining conduits with mechanical couplings. The rapid-cure, twopart resin adhesive forms a strong watertight and airtight seal and delivers a durable bond that can withstand movement and vibration. Ideal for installation along roadsides or near electrical equipment like transformers or switchgear.

#### Features & Benefits

- **VERSATILE**  
Bonds HDPE to PVC, rigid steel, fiberglass conduits and fittings, and transition couplings
- **SUPERIOR**  
Stronger pullout strength than most mechanical couplings
- **COST EFFECTIVE**  
Less expensive than mechanical couplings
- **CONVENIENT**  
Kits contain all application components required for a quick installation



BT-KIT

BTXL-250CART12

Part No.	Description
BT-KIT	2 x 50 ml Adhesive Cartridges 8 x Mixing Nozzles 1 x Strip Sanding Cloth 8 x Type RP™ Cleaning Wipes (cat# RP-1)
BTXL-250CART12	12 x 250 ml Adhesive Cartridges 12 x Mixing Nozzles 1 x Strip Sanding Cloth 12pr x Gloves 1 x Instruction Sheet



To Watch the BonDuit Application Video SCAN or CLICK the QR-Code

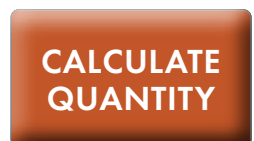

Click the above to calculate the number of cartridges required for your project

## Conduit / Duct Sealant Systems

### AFT Sealant System - Polywater

Polywater® AFT closed-cell sealant provides 10 feet of water-blocking performance in electrical and telecommunication environments. The two-part, closed-cell AFT Sealant is durable and easy to install. AFT has excellent adhesion to a variety of conduits. AFT seals conduits with quicker installation and higher performance compared to duct putty or single-part insulating hardware store foams. The two-part aerosol foam seals any size void and cures without exposure to air. AFT expands and cures to a rigid, closed-cell structure in minutes.

AFT creates an airtight, watertight seal. AFT can be used to seal service entrances, conduit, inner-ducts, inverters and combiners for solar installations, and riser poles for the electrical grid. AFT protects against insects, rodents, moisture, dust, and gases. The package is reusable, and the fire-retardant seal is self-extinguishing.

#### Polywater™ AFT Features

- Quick Installation: 2-minute application time or less.
- Multiple-Use Can: Creates numerous seals in all types of ducts.
- Reliable: Holds 10 feet of continuous water head pressure.
- Durable: Withstands cold temperature applications.
- Removable: Product can easily be removed to replace cable.

**Cable Compatibility:** AFT two-part foam sealant is compatible with common cable jacket materials. It does not change physical or electrical properties of cable, based on tensile/elongation and volume resistivity testing. The cured foam is an inert solid that does not affect cable components.

**Approvals:** AFT is a UL recognized component and passed UL94 with a Class HBF fire retardant rating.

**Cure Rate:** AFT two-part foam sealant can be used at temperatures down to 7°C (45°F). At lower temperatures the reaction slows, but the sealant will completely foam and cure with time. AFT foam expands two times its volume as it is dispensed. Full expansion is complete in under 2 minutes at 21°C (70°F). It will take 3 to 5 minutes to be tack free. During this time do not move cables or touch foam.

**For sealing conduits and risers from moisture, gases and vermin**



To Watch the AFT Application Video  
SCAN or CLICK the QR-Code

Part No.	Description
AFT-16	1 x 16oz (473ml) can - 2 actuators per
AFT-16P4	4 x 16oz (473ml) can - 2 actuators per
AFT-SAE10	10 pack of actuators with STANDARD extension tube
AFT-FAE10	10 pack of actuators with FLEXIBLE extension tube





To Watch the FST Application Video  
SCAN or CLICK  
the QR-Code



# CABLE INSTALLATION EQUIPMENT

## CONTENTS

### FST Sealing System - Polywater

FST™ Duct Seal is a “closed cell foam”, with high density properties, this keeps water, acids, greases, gases, insects and rodents out of the conduit.

The foam has good wetting and adhesion to metals, plastics, and concrete.

#### Features

- FST Duct Sealant™ has 98% closed-cell content for increased strength and resiliency
- FST Duct Sealant™ resists 6.7m of water-head pressure
- FST Duct Sealant™ is compatible with cable and duct materials
- FST Duct Sealant™ is chemically resistant to gasoline, oils, dilute acids and bases, and most unsaturated hydrocarbons
- Prevents the passage of gas; does not sag; will not dry out; and is re-alterable
- Quick: Foam expands and cures quickly even when water is present
- Multi-Use: Packages are resealable

### FST-250KIT1 Duct Sealant - Polywater

#### Part No. FST-250KIT1

FST™ Quick setting Duct Sealant in a 2 part 250ml field ready cartridge kit.

Recommended for conduits 50 to 200mm

Part No.	Kit Includes
FST-250KIT1	1 x 240g two-part Foam Sealant caulking tube style with resealing cap 3 x Mixing nozzles, 4 x 600m Foam damming strips 1 x Position rod, 1 x Pre-treating wipe, Instruction Sheet



Click the below to calculate the number of cartridges required for your project

**CALCULATE QUANTITY**

### FSTBP™ Duct Sealant Burst Pack - Polywater

#### Part No. FSTBP-200KIT1

FSTBP Duct Sealant comes in an easy to use, self-dispensing burst pack.

Ideal for the protection of conduits 125mm to 200mm.

Part No.	Kit Includes
FSTBP-200KIT1	1 x FSTBP-200KIT1-200 Burst Pack 1 x Pair of gloves, 1 x Sanding cloth 4 x Foam Strips, 1 x Prep. Wipes, 1 x Instructions

### FST MINI Duct Sealant - Polywater

#### Part No. Various

#### Effectively Seals Small Conduits and Inner-ducts

Polywater® FST™ MINI is 50ml field ready kit.

Recommended for small conduits 20 to 50mm.

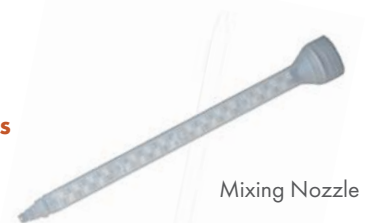

Mixing Nozzle

Part No.	Description
FST-MINI	1 x 50ml FST Cartridge, 2 x Mixing Nozzles, 6 x Foam Discs 1 x Pair of gloves, 1 x Instructions
TOOL-50-11	Application Tool

## TESMEC



### Hydraulic Pullers

#### 15kN Hydraulic Puller - Tesmec

**Part No. ARS200**

The **ARS200** Hydraulic Puller is suitable to string one rope. The bull wheel grooves are made of heat treated steel.

Configuration	
•	Negative self-acting hydraulic brake
•	Hydraulic dynamometer with set-point and automatic control of maximum pull
•	On board reel winder with automatic level wind and special reel BOF370 for 500m of 8mm rope

Characteristics	
Bull Wheel dia (mm)	200
Max rope dia (mm)	8.0
Weight (without rope) (kg)	500

Engine	
Petrol (kW)	13 (18hp)
Cooling System	Air
Electrical System (V)	12

Performance	
Max pull (kN)	15
Speed at max pull (km/hr)	0.7
Max speed (km/hr)	3.6
Pull at max speed (kN)	4
Hydraulic Transmission	
Closed hydraulic circuit for stepless speed variation in both rotating directions	



MAX PULL

15kN



MAX SPEED

0.7km/h



ROPE DIAMETER

8mm

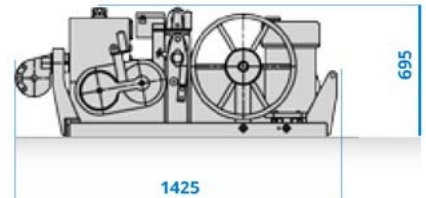

#### 30kN Hydraulic Puller - Tesmec

**Part No. PL1150**

The **PL1150** Hydraulic Puller is suitable to string one rope. The bull wheel grooves are made of wear proof thermally treated steel.

Configuration	
•	New Digital HMI 127mm (5") display
•	Negative self-acting hydraulic brake
•	On board automatic reel winder
•	Pull recorder & Digital meter counter

Characteristics	
Bull Wheel dia. (mm)	350
Max. rope dia. (mm)	13
Mass (without rope) (kg)	980

Engine	
Diesel (kW)	19 (26hp)
Cooling System	Water
Electrical System (V)	12

Performance	
Max pull (kN)	30
Speed at max. pull (km/hr)	1
Max speed (km/hr)	3.2
Pull at max. speed (kN)	10
Hydraulic Transmission	
Closed hydraulic with pull pre-setting system that automatically adjust pulling speed.	



MAX PULL

35kN



MAX SPEED

3.6km/h



ROPE DIAMETER

13mm

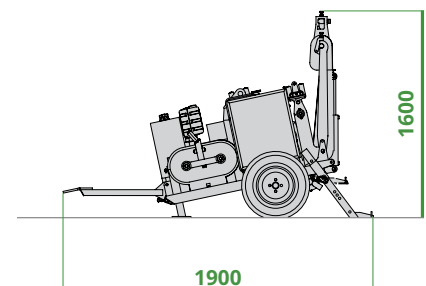

### 35kN Hydraulic Puller - Tesmec

Part No. ARS403

The **ARS403** Hydraulic Puller is suitable to string one rope. The bull wheel grooves are made of wear proof thermally treated steel.



Performance	
Max pull (kN)	35
Speed at max pull (km/hr)	1.2
Max speed (km/hr)	3.6
Pull at max speed (kN)	12
Hydraulic Transmission	
Closed hydraulic circuit for stepless speed variation in both rotating directions	

**Ideal for Overhead & Underground Projects**

Configuration	
<ul style="list-style-type: none"> <li>Negative self-acting hydraulic brake</li> <li>Hydraulic dynamometer with set-point and automatic control of maximum pull</li> <li>On board reel winder with automatic level wind suitable for standard reel BOF010 and BOF020 (AXR001 included)</li> </ul>	



MAX PULL

35kN



MAX SPEED

3.6km/h



ROPE DIAMETER

13mm

Characteristics	
Bull Wheel dia (mm)	325
Max rope dia (mm)	13
Weight (without rope) (kg)	980

Engine	
Gasoline (kW)	25 (34hp)
Cooling System	Water
Electrical System (V)	12

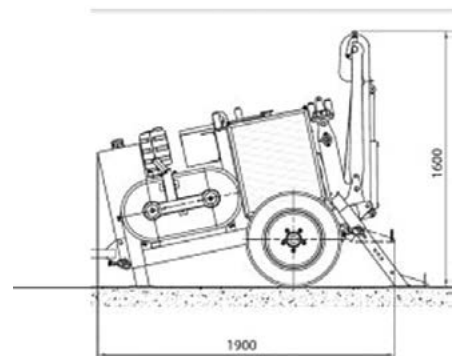

Performance	
Max pull (kN)	70
Speed at max. pull (km/h)	1.2
Max speed (km/h)	4
Pull at max. speed (kN)	21
Hydraulic Transmission	
Closed hydraulic circuit for stepless speed variation in both rotating directions	

### 70kN Hydraulic Puller - Tesmec

Part No. ARS523

The **ARS523** is a light and simple completely electronically controlled Hydraulic Puller.

Configuration	
<ul style="list-style-type: none"> <li>Negative self-acting hydraulic brake</li> <li>Hydraulic dynamometer with set-point and automatic control of maximum pull</li> <li>On board reel winder with automatic level wind suitable for standard reel BOF010 and BOF020 (AXR001 included)</li> </ul>	



MAX PULL

70kN



MAX SPEED

4.0km/h



ROPE DIAMETER

16mm

Characteristics	
Bull Wheel dia. (mm)	400
Max. rope dia. (mm)	16
Mass (without rope) (kg)	2100
Number of grooves	7
Suitable for	1 rope
Layout	Single

Engine	
Diesel (kW)	55 (75hp)
Cooling System	Water
Electrical System (V)	12

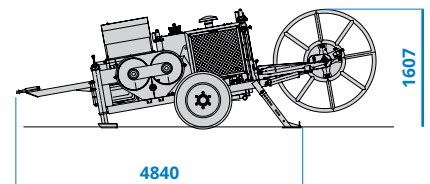

## TESMEC



### NEW DIGITAL HMI\*

The 178mm (7") color display indicates machine working parameters, maintenance records and has integrated pull and speed recorder.

### REMOTE CONTROL

The radio remote control provides total user machine control while integrating with the new digital user interface.

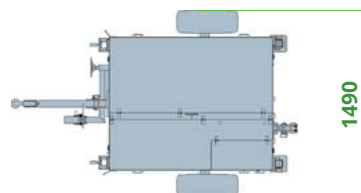
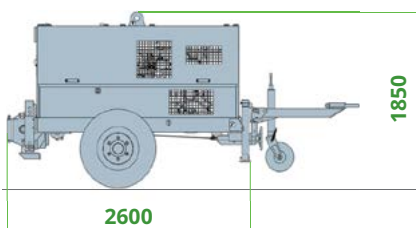
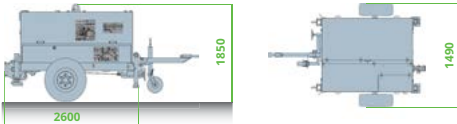

## All Electric Winch | Cleaner | Quieter | Greener

### 30 & 50kN Battery Puller - Tesmec

#### Part No. PE1150 & PE1250

The Tesmec PE1150 & PE1250 Battery powered pullers are an industry exclusive. With an electric motor, they eliminate the need for hydraulic components such as hydraulic motors, pump and valves, and requires no oil. The unit's silent operation makes it ideal for almost any location, while the electric power system generates zero emissions. The PE1150 & PE1250 delivers a maximum pull force of 30kN & 50kN respectively and offer an advanced user interface and remote control.

#### Features

- Setting pull value
- Setting reel winder value
- Control of direction and speed of bull-wheels
- Display to check stringing parameters
- Stop Operation push button
- Negative self-acting electrical brake
- Lockable sound proof integrated covers
- Automatic reel winder with automatic level wind
- Earthing connection point
- Mechanical front and rear stabilizers
- Free-wheel device
- Electronic pull value limitation control
- Integrated warm-up system

### 70kN Hydraulic Puller - Tesmec

#### Part No. PM1300

- New Tesmec digital HMI. Automatic re-winder.
- Full sound proof cover. Negative hydraulic brake with automatic intervention.
- Rigid axle 30 km/h.
- Connection point for grounding. Hydraulic front share.
- Neutral system.
- Electronic fire limitation control Integrated heating system.

The perfect Machine for Urban Underground Pulling

Performance	PE1150	PE1250
Max pull (kN)	30	50
Speed at max pull (m/min)	15	10
Max speed (m/min)	70	70
Pull at max speed	5	5
Free wheel max speed (m/min)	70	70

Characteristics	PE1150	PE1250
Bull-wheel diameter (mm)	250	300
Max rope diameter (mm)	11	13
Weight (without rope) (kg)	2350	2500
Number of grooves	8	8
Suitable for	1 rope	1 rope
Layout	Single	Single

Electric Power Pack	PE1150	PE1250
Battery Pack (V)	96	350
Charge Time (Hr @ 230V)	5	5

BATTERY STORAGE CAPACITY	PE1150	PE1250
Rope length recovered		
Working Cycle (Average) (m)	5000	7000
Working Cycle (Max Pulling Force) (m)	1300	1400

Performance	
Max pull (kN)	70
Speed at max. pull (m/min)	7
Max speed (m/min)	70
Pull at max. speed (kN)	5
Free wheel max speed (m/mm)	70

Characteristics	
Bull Wheel dia. (mm)	300
Max. rope dia. (mm)	15
Mass (without rope) (kg)	2500
Number of grooves	8
Suitable for	1 rope
Layout	Single

Electric Power Pack	
Battery Pack (V)	350
Charge Time (Hr @ 208V)	4

## 30kN Hydraulic Puller - Tesmec

Part No. PM1150



(with ALL112)

### Features

- Lockable sound proof integrated covers
- Negative self-acting hydraulic brake
- Rigid axle 30 km/h
- Grounding connection point
- Digital metre counter
- Control instruments
- Diesel engine
- Mechanical front and rear stabilisers
- Onboard reel winder with automatic level wind and reel for 1000m of d. 10mm rope

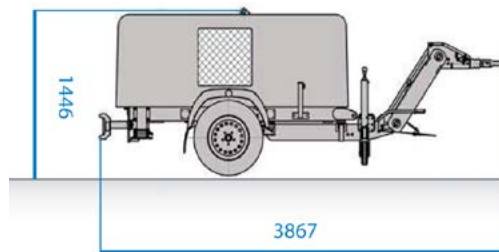
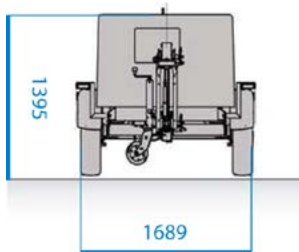

Performance	
Max pull (kN)	30
Speed at max. pull (m/min)	13
Max speed (m/min)	42
Pull at max. speed (kN)	9

Characteristics	
Max. rope dia. (mm)	12
Mass (without rope) (kg)	1100
Suitable for	1 rope
Layout	Single

Engine	
Diesel (kW)	18.8 (25.5hp)
Emission level	tier 4f/Stage V
Cooling System	Water
Electrical System (V)	12



## 50kN Hydraulic Puller - Tesmec

Part No. PM1250

The PM1250 Hydraulic Puller is suitable to string one rope and operates using the latest in technology from Tesmec.

### Features

- Utilises New Tesmec digital HMI\*
- Automatic reel winder
- Lockable sound proof integrated covers
- Negative self-acting hydraulic brake
- Rigid axle - 30km/h
- Earthing connection point
- Mechanical front and rear stabilizers
- On board reel winder with automatic level wind and reel for 700m of 14mm dia. rope
- Free wheel device
- Electronic pull value limitation control
- Hydraulic Transmission: Closed hydraulic system for stepless speed variation in both directions

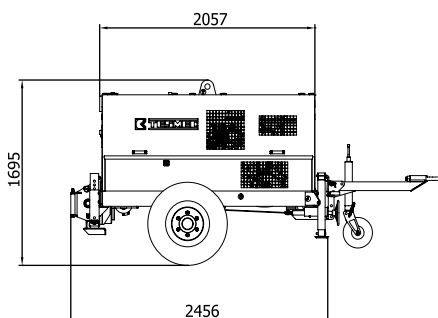

Performance	
Max pull (kN)	50
Speed at max. pull (m/min)	17
Max speed (m/min)	67
Pull at max. speed (kN)	12.5
Free wheel max speed (m/min)	150

Characteristics	
Bull Wheel dia. (mm)	350
Max. rope dia. (mm)	14
Mass (without rope) (kg)	2000
Number of grooves	7
Suitable for	1 rope
Layout	Single

Engine	
Diesel (kW)	42 (56hp)
Emission level	tier 4f/Stage IIIB
Cooling System	Water
Electrical System (V)	12

\*See Transmission Stringing for further information on "Digital HMI"

### iTOOLco.

To Watch the CM3K in action, SCAN or CLICK the QR-Code



## Battery Capstan Winches

### Battery Capstan Winch - 1360kg - iTOOLco

#### Part No. CM3K

Ideal for Industrial/Commercial applications. Pulling from remote locations is no longer a challenge. This portable 1360kg puller is intuitively designed to handle all of your day-to-day pulls.

Speed, Versatility, and Performance are all yours with iToolco's Battery Capstan Winch.

The built-in capstan switch automatically turns the puller on and off. Simply tug on the rope to start the pull and back off to shut it down.

Delivers dynamic performance in remote locations or areas where power is not yet available.

**Powered by Milwaukee Batteries**

Versatile Dual Capstan



Part No	Ordering information	Dimensions Collapsed (mm)	Dimensions Extended (mm)	Wt (kg)
CM3K	Winch, Conduit Adaptors & Rack Motor, 2 x Batteries, Charger	914 (W) x 686 (H) x 2120 (L)	914 (W) x 686 (H) x 2900 (L)	62.3
Pull Speed		Max Pulling Capacity (kg)		Pull at Max Speed (kg)
Small Capstan	Large Capstan	1360		682
Up to 15.2m/pm - 1360kg	Up to 32.9m/pm - 682kg			

### iTOOLco.

To Watch the UMP3K in action, SCAN or CLICK the QR-Code



### Battery Capstan Winch - 1360kg - iTOOLco

#### Part No. UMP3K

Ideal for Utility Applications

Includes Tow-bar Mount

Get high-speed performance and a unique set-up with iTOOLco's 3K Utility Puller™.

Designed for quick set-up, the 3K Utility Puller's articulating receiver adapter can be positioned 180 degrees vertically or horizontally at the precise angle needed to get the job done.

With this hardworking puller you can transfer heavy pulling loads to the ground within centimeters of the conduit you're pulling through.

For overhead pulls, line guide rollers keep the rope centered on the capstan.

**Powered by Milwaukee Batteries**

Versatile Dual Capstan



Part No	Ordering information	Dimensions Collapsed (mm)	Dimensions Extended (mm)	Wt (kg)
UPM3K	Winch, Milwaukee Motor, 2 x Batteries, Charger	508 (H) x 508 (W) x 1900 (L)	508 (H) x 508 (W) x 2900 (L)	74.1
Pull Speed		Max Pulling Capacity (kg)		Pull at Max Speed (kg)
Small Capstan	Large Capstan	1360		682
Up to 15.2m/pm - 1360kg	Up to 32.9m/pm - 682kg			

**iTOOLco.**



To Watch the CD6K in action, SCAN or CLICK the QR-Code



## Battery Capstan Winch - 2720kg - iTOOLco

### Part No. CD6K

Ideal for Industrial/Commercial or OH & UG applications. . When 2T is not quite enough and you don't want to drag a big puller around on your vehicle, this iTOOLco winch is the ideal puller.

Speed, versatility, and performance are all yours with iTOOLco's Cordless Cannon 6K™.

This portable 2720kg puller is intuitively designed to handle all of your day-to-day wire pulls.

The built-in capstan switch automatically turns the puller on and off. Simply tug on the rope to start the pull and slack off the rope to shut it down.

Delivers dynamic performance in remote locations or areas where power is not yet available.

**Powered by  
Dewalt  
Batteries**



Part No	Description	Dimensions Collapsed (mm)	Powered by	Wt (kg)
CD6K	Winch, Conduit Adaptors & Rack Motor, 2 x Batteries, Charger	1220H x 546W x 546L	Battery OPERATED 4 speed Dewalt motor	62
Pull Speed		Max Pulling Capacity (kg)	Pull at Max Speed (kg)	
Small Capstan	Large Capstan			
Up to 4.9m/pm - 2720kg		2720	1360	

**iTOOLco.**

**Pulls at  
11 m  
Per Minute**



## Electric Capstan Winch

### Electric Capstan Winch - 5450kg - iTOOLco

#### Part No. C12K-230

Fully self-contained, compact Cannon 12K™ wire puller has a 6-speed 230V reversible motor.

Designed specifically for easy set up to meet job site demands with all parts store on the puller. No large storage box of parts needed.

When extra extensions are used, the wire puller is capable of pulling out 3.9m of wire from the conduit opening.

This cable puller is easy to maneuver, and can be changed quickly from side pulls to overhead or underground.

iTOOLco's Cannon 12K™ pulls at speeds up to 11m per minute.



Part No	Description	Dimensions Collapsed (mm)	Powered by	Wt (kg)
C12K-230	Winch, Conduit Adaptors, Rack & 230V Motor	1730 (L) x 762 (W) x 1450 (H)	230V motor	183
Pull Speed		Max Pulling Capacity (kg)	Pull at Max Speed (kg)	
Small Capstan	Large Capstan			
Up to 4.5m/pm - 5450kg		5450	2720	

## Winches Accessories



### Tripod For 3K and 6K Pullers - iTOOLco

**Part No. TP01**

- Use over manholes and pull boxes/vaults
- Attaches to the Cannon 3 & 6K Cable Pullers
- Utilises Pullers integrated roller system for vertical pulls
- No tools required



Part No.	Description	Dimensions	Wt (kg)
TP01	Tripod Support for 3 & 6K Pullers	914 (L) x 152 (W) x 1651 (H)	16

Puller not included

## Running Line Tension Gauge

### Running Line Tension Gauge - Safe Pull - iTOOLco

**Part No. SPRLT20K**

**Accurately Monitor Cable Tension & Customer Overload Limits**

- Measure loads up to 88kN (9T).
- Easy Rope Installation with quick release pins
- Accepts rope sizes 4mm to 19mm
- Overhead & Right Angle Pulls
- Smart-Phone App available for Apple and Android platforms
- Light-weight and Durable - Constructed from anodized aluminium.
- No structural Plastic parts
- Mounting Kit Included
- Reads in kN - kg - t - lb
- Accepts AA Batteries (500hr battery life)
- IP67 Rated

**Contact TEN for information on the Smart Phone APP**

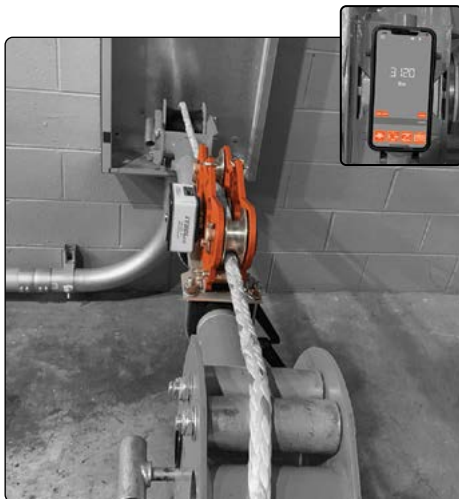

To Watch the Tensioner in action, SCAN or CLICK the QR-Code



Part No	Description	Dimensions (mm)	Wt (kg)
SPRLT20K	Running Line Tensioner	422 (L) x 35 (W) x 152(H)	4.6



### Electric Drill Operated Capstan Winch

#### Drill Operated Cable Puller - 454kg - Current Tools

##### Part No. 11

This small but powerful Drill Operated Cable Puller offer a maximum pulling capacity of 455kg, weighing in at under 7kg

##### Features

- Designed for one person set-up and operation
- 455kg max capacity with 270kg continuous
- Accepts most 18v cordless drills
- Telescoping boom easily extends over 1 m in length
- Quickly unload poly-line with removable capstan plate
- For use with any size conduit from 13 to 100mm
- Adapter coupling for adding stabilizing leg



Part No	Description	Capacity (kg)	Powered by	Wt (kg)
11	Drill Operated Capstan Winch	454 Max - 270 Continuous	Most 18V Battery Drills	6.8

### Battery Operated Capstan Winch

#### Battery Cable Puller - 1500kg - Current Tools

##### Part No. 33BAT

The 33BAT is a compact and versatile Battery operated Cable Puller mounted on its own mobile cart. Speed and performance at your fingertips. Keep your hands free with the built-in foot switch.

##### Features

- Mobile cart for easy mobility around job-site
- Folds for compact transport and storage
- 2.4m reach when fully extended
- Full set of quick release conduit couplings included
- Integral heavy duty 18 volt, 2-speed motor
- Integral foot switch
- Complete system – no extra parts to purchase
- Flat free wheels
- Extra battery storage for quick power change
- Pulls up to 22m per minute High Speed (no load)
- Attach to a vehicle via Hayman Reece adaptor



**Powered by Milwaukee Batteries**

Part No	Description	Dimensions Collapsed (mm)	Powered by	Weight (kg)	Weight (kg)
33BAT	Battery Powered Capstan Winch	1220H x 559W x 584D	Battery Operated Milwaukee motor	38 Winch	59 Complete
Pull Speed		Max Pulling Capacity (kg)		Rope	
Low	High				
Up to 4.9m/pm	Up to 22m/pm	1500		13mm or larger Double Braid	

# CHANCE®

## Capstan Winches and Accessories

### Capstan Winches - 454kg - Chance

Chance Capstan Winches are available for all on-site situations.

**Hydraulic** - Powered by 700bar (10,000psi) Hydraulic Pump

**230V AC** - Plug into any single phase power outlet or a truck inverter

**Petrol** - Utilise independently of all other power supplies

Improved design features a multi-planetary drive/backstop clutch, assembled on the centre shaft of the steel gear-case with full-length internal teeth.

This design handles more rugged conditions, extends life and reduces maintenance

For improved load control, steel capstan drum features nickel-plated rope surface, larger radius at load-line wrap and rope hook.



Hydraulic Winch shown with Rope Lock (sold separately)

### Versatile Application

Lightweight, powerful portable winches move heavy weights and tackle difficult to access tasks, including:

- Pulling underground and indoor cable
- Stringing and tensioning conductors
- Lifting transformers



Honda 35cc 4 Stroke Engine

- Hoisting heavy insulator strings
- Tower erection
- Pulling wheeled equipment over obstacles



Petrol Winch shown with Foot Switch (included)

### Petrol Winch - Honda 35cc 4-Stroke - Chance

Part No. C308-1190

Capacity (kg)	Speed at Max Load (m)	Source required for speed	Wt (kg)
454	12.2	7,000rpm	20.9

Includes Foot Switch

### Electric Winch - 230V AC - Chance

Part No. C308-1171

Included Foot switch



Capacity (kg)	Speed at Max Load (m)	Source required for speed	Wt (kg)
454	6.4	7 amps motor current	22.5

Includes Foot Switch

### Hydraulic Winch - 700bar (10,000psi) - Chance

Part No. C308-1180

Capacity (kg)	Speed at Max Load (m)	Source required for speed	Wt (kg)
454	28.3	30lt per min @ 10,000psi	12.9

Foot Switch not Included - see accessories page (B43)

See following page for available accessories





### Rope Lock Device - Chance

**Part No. C308-0856**

- Automatically supports load if rope is released
- Accepts 12.7mm to 19.0mm rope
- Includes 2 mounting bolt, washers and lanyard



### All Purpose Mounting Bracket - Chance

**Part No. C308-1335**

- Fits all 454kg Capacity winches
- Includes two chain clamps for poles



### Universal Mounting Bracket - Chance

**Part No. C308-0925**

- Recommended for petrol Winch
- Can be bolted down or uses two C417-0346 Chain Clamps (below) for mounting on poles, angles and beams



### Chain Clamp - Chance

**Part No. C417-0346**

- Recommended for above Universal Bracket
- Use two Chain Clamps for Universal Bracket (above)
- 2.15m long



### Swivel Base Truck Mount - Chance

**Part No. T308-1506**

- Recommended for Electric and Hydraulic Winches
- Weight: 10.4kg



### Swivel Base Truck Mount & Hitch Mount - Chance

**Part No. PSC3081563**

- Recommended for Electric and Hydraulic Winches
- Weight: 28.1kg



### Foot Switch - Hydraulic - Chance

**Part No. C308-0685**

- Use for Hydraulic Winch
- Weight: 10.9kg



## CONTENTS



## Petrol Capstan Winch

### Portable Petrol Capstan Winch - Docma

Part No. VF900-4

Docma Portable Capstan Winch equipped with the Honda 4-stroke engine  
Designed for all your Pulling, Hauling & Lifting projects

#### Features

- Made in Italy from high quality materials
- Honda 4-Stroke GX50 Engine, meets Australian Emission Standards
- Variable speed controlled by rope tension
- High quality reducer with helical tooth gears

#### Used For

- Underground Cable Hauling
- Overhead conductor stringing
- Lifting equipment on pole and towers
- Tree lopping and felling, including directional felling
- Ground clearing & firewood collection
- Camping, hunting & 4X4
- AND MUCH, MUCH MORE

**LOW NOISE  
LOW EMISSION**



Click or Scan to view Rope set-up

#### Winch Specifications

Part No.	Capacity (kg)			Engine type	Pull Speed (m/pm)	Engine (kw/hp)	Rope		Wt (kg)
	Pulling	Double Rope	Lifting				Size (mm)	Wraps on Drum	
VF900-4	865	1730	200	Honda 4 Stroke GX50	14	1.47/2.0	10 / 12**	4/5	10.85

\*\* 10 and 12mm Double Braid Polyester Hauling Rope available in a variety of lengths.

#### Mounting Accessories - Docma

Contact TEN for a full layout of Accessories



Ground Mount  
Part No. VF310504



Accessory Mount  
Part No. VF310500



Pole-Tree-Tower Mount  
Part No. VF310501



Vertical Lift/brake Mount  
Part No. VF310503



Hayman Reece Adapter  
Part No. VF310506



Hook/Sling Attachment  
Part No. VF310211

### Petrol Drum Winch

#### Portable Petrol Drum Winch - Docma

Docma offer a highly innovative range of Winches for Pulling loads for the Power Utilities, Telecommunication, Railway, Mining, Oil & Gas industries.

They combine Italian quality materials, modern and functional design to achieve excellent Performance, Speed and Portability. Perform these tasks in remote locations or areas where power is not available.

The portable Drum winches are designed to handle all of your day-to-day pulls from loads of up to 1485kg (2970kg via single pulley)



VF155-AUTO

#### Features

- Italian Quality
- Pulling from remote locations no longer a challenge
- Ready for immediate use on site
- Quickly mobilised and placed in working position
- Over 1.4 tonne capacity
- Innovative quick release system for free-wheel unwinding
- Textile rope
- Balanced Carry Handle
- Wide range of accessories
- Steel Rope version available upon request



Auto Rewind Guide



Hook or Tow-Ball Attachment

Part No.	Pull Capacity (kg)	Dimensions (mm)	Pull Speed	Engine (cc)	Rope Dia & Length	Rope Type	Wt (kg)
VF155-AUTO	1485	595 x 385 x 360	20m/min	50.8	5mm x 80m	Textile	25.0

#### Capstan & Drum Winch Accessories - Docma

Docma offers a wide range of accessories to handle all of your day-to-day pulling, from poles, trees and towers to vehicle tow-balls.

#### Slings & Ratchet Strap



Double Ended Sling



Ratchet Strap

#### Redirection or double capacity Pulleys



16kN Steel Pulley



16kN Steel Pulley



40kN AL Pulley



40kN AL Pulley

#### Hooks & Shackles



Rated Hooks and Shackles

#### Replacement Ropes for Drum Winches



Textile Rope



Steel Rope

Wide range of other accessories available including equipment bags & back-packs and, pole, tree & equipment sleighs & trolleys

## NOTES

A series of horizontal dotted lines for taking notes, spanning the width of the page.



## NOTES

A series of horizontal dotted lines spanning the width of the page, intended for taking notes.



## TEN Group

The Energy Network (Australia) Pty Ltd | ABN 72 093 052 441

### QUEENSLAND

2B, 605 Zillmere Road  
ZILLMERE 4034

**P** +61 7 3212 8999

**W** [www.tengroup.com.au](http://www.tengroup.com.au)

**E** [salesqld@tengroup.com.au](mailto:salesqld@tengroup.com.au)

### TEN HIRE

2B, 605 Zillmere Road  
ZILLMERE 4034

**P** +61 7 3212 8999

**W** [www.tenhire.com.au](http://www.tenhire.com.au)

**E** [hire@tengroup.com.au](mailto:hire@tengroup.com.au)

### NEW SOUTH WALES

Suite F2, Level 1  
152-156 Pacific Highway  
TUGGERAH NSW 2259

**P** +61 417 631 443

**E** [salesnsw@tengroup.com.au](mailto:salesnsw@tengroup.com.au)

### VICTORIA

Unit 16, 191-195 Greens Road,  
DANDENONG STH VIC 3175

**P** +61 3 9793 1622

**E** [salesvic@tengroup.com.au](mailto:salesvic@tengroup.com.au)

### WESTERN AUSTRALIA

4/15 Baile Road  
CANNING VALE WA 6155

**P** +61 8 9455 5574

**E** [saleswa@tengroup.com.au](mailto:saleswa@tengroup.com.au)

### TASMANIA | STH AUSTRALIA

Unit 19, 15 Stanton Place  
CAMBRIDGE TAS 7170

**P** +61 499 996 441

**E** [salestas@tengroup.com.au](mailto:salestas@tengroup.com.au)

